

CORE

HEALTH & FITNESS

NAUTILUS StairMaster STAR TRAC SCHWINN
THROWDOWN COREFIT COLLECTIVE GYM RAX wexer



Product Catalog



Table of Contents

CARDIO	8	IMPACT SPORTS	100
<ul style="list-style-type: none"> • Treadmills • Climbing • Ellipticals 	<ul style="list-style-type: none"> • Upright & Recumbent Bikes • Virtual Bike • Consoles 	<ul style="list-style-type: none"> • Throwdown 	
GROUP EX	28	FIT ACCESSORIES	110
<ul style="list-style-type: none"> • Throwdown HIIT 	<ul style="list-style-type: none"> • Schwinn Cycling 	<ul style="list-style-type: none"> • Consoles 	
STRENGTH	40	ANYWHERE FITNESS	122
<ul style="list-style-type: none"> • Inspiration • Impact • HumanSport 	<ul style="list-style-type: none"> • Leverage • Plate Loaded • Multi-Stations 	<ul style="list-style-type: none"> • Benches • Racks • Instinct 	<ul style="list-style-type: none"> • Wexer Virtual • Web Player and App • Wexer API
FUNCTIONAL TRAINING	88	EDUCATION	124
<ul style="list-style-type: none"> • Throwdown 		CUSTOMER SERVICE	126



Gym Rax delivers modular, space-efficient training systems crafted for hospitality, multi-housing, and corporate wellness environments. Thoughtfully engineered with refined finishes and architectural presence, Gym Rax transforms underutilized spaces into purposeful, performance-driven destinations. Full product integration into the Core catalog is coming soon. Until then, explore the complete lineup at gymrax.com.

CARDIO

Since its founding in 2010, Core Health & Fitness has built on the legacies of its iconic brands—StairMaster and Star Trac—to lead the way in main floor cardio solutions.

For over 40 years, StairMaster has been a game-changer, delivering the intense, results-driven workouts that challenge members to push their limits. From raising heart rates to torching calories, equipment like the legendary StairMaster and Jacobs Ladder are built to make it “easier to work harder,” offering the kind of workout people love to hate—and keep coming back for.

Founded in 1979, Star Trac has always been about inspiring movement. With a focus on creating intuitive, reliable equipment, Star Trac empowers operators to offer experiences that drive member engagement and help foster lifelong fitness habits. Powered by advanced technology and OpenHub™ connectivity, Star Trac products are designed to fit seamlessly into any fitness program while delivering an elevated user experience.

Together, StairMaster and Star Trac bring a legacy of innovation and performance that fuels results and enhances every step of the fitness journey. At Core Health & Fitness, we believe in building connections between operators and their members by offering equipment that inspires movement, delivers results, and creates new opportunities for success on the cardio floor.



TREADMILLS	6
CLIMBING	10
ELLIPTICALS	12
UPRIGHT AND RECUMBENT BIKE	15
VIRTUAL BIKE	17
CARDIO CONSOLES	18

CARDIO

Treadmills



Star Trac FreeRunner™ 10 TRx

DIMENSIONS	81 x 35 x 60 in (207 x 88 x 152 cm)
DECK SYSTEM	Two piece aluminum deck with phenolic sheet
DECK CUSHIONING	HexDeck aluminum deck supported by proprietary hexagonal suspension system provides a revolutionary combination of shock absorption + response
RUNNING SURFACE	60 x 22 in (152 x 55 cm)
INCLINE RANGE	0 - 20% max incline
SPEED RANGE	0.5 - 15 mph (0.5 - 24 kmh)
STEP-UP HEIGHT	11 in (28 cm)
PRODUCT WEIGHT	515.2 lbs (233.7 kg)



Shadow Edition, featuring Black Hex Deck, also available

FEATURES:

- Wireless phone charger
- Apple + Samsung watch tap to pair for data tracking
- Cup Holders



Star Trac 8TRx

DIMENSIONS	81 x 35.5 x 60 in (206 x 90 x 152 cm)
DECK SYSTEM	Reversible MDF deck with phenolic coating
DECK CUSHIONING	SoftTrac® technology - Triple cell cushioning system provides maximum shock absorption making the entire deck a sweet spot
RUNNING SURFACE	60 x 22 in (152 x 55 cm)
INCLINE RANGE	0 - 20% max incline
SPEED RANGE	0.5 - 15 mph (0.5 - 24 kmh)
STEP-UP HEIGHT	10 in (25.4 cm)
PRODUCT WEIGHT	465 lbs (211 kg)

FEATURES:

- Wireless phone charger
- Apple + Samsung watch tap to pair for data tracking
- Cup Holders



Star Trac 8TR

DIMENSIONS	81 x 35 x 60 in (207 x 88 x 152 cm)
DECK SYSTEM	Reversible MDF deck with phenolic coating
DECK CUSHIONING	SoftTrac® technology - Triple cell cushioning system provides maximum shock absorption making the entire deck a sweet spot
RUNNING SURFACE	60 x 22 in (152 x 55 cm)
INCLINE RANGE	0 - 15% max incline
SPEED RANGE	0.5 - 12.5 mph (0.5 - 20 kmh)
STEP-UP HEIGHT	9 in (23 cm)
PRODUCT WEIGHT	460.2 lbs (208.8 kg)

FEATURES:

- Wireless phone charger
- Apple + Samsung watch tap to pair for data tracking
- Cup Holders



Star Trac STRc

DIMENSIONS	81 x 32 x 58 in (206 x 81 x 147 cm)
RUNNING SURFACE	60in x 22in (152cm x 55cm)
INCLINE RANGE	0-15% max incline
SPEED RANGE	0.5 - 12.5 mph (0.5 - 20 kmh)
STEP-UP HEIGHT	7 in (17.8 cm)
PRODUCT WEIGHT	381 lb (173 kg)

CARDIO

Treadmills



Star Trac 6TR

DIMENSIONS	81x 32 x 60 in (206 x 81 x 152 cm)
RUNNING SURFACE	60 x 22 in (152 x 55 cm)
INCLINE RANGE	0-15% max incline
SPEED RANGE	0.5 - 12.5 mph (0.5 - 20 kmh)
STEP-UP HEIGHT	7 in (17.8 cm)
PRODUCT WEIGHT	460 lb (208 kg)

FEATURES:

- Wireless phone charger
- Apple + Samsung watch tap to pair for data tracking
- Cup Holders



Star Trac 4TR

DIMENSIONS	81x 32 x 60 in (206 x 81 x 152 cm)
RUNNING SURFACE	60 x 22 in (152 x 55 cm)
INCLINE RANGE	0-15% max incline
SPEED RANGE	0.5 - 12.5 mph (0.5 - 20 kmh)
STEP-UP HEIGHT	7 in (17.8 cm)
PRODUCT WEIGHT	399 lb (181 kg)

**Light commercial rated*



Star Trac STRx

DIMENSIONS	81x 32 x 55 in (206 x 81 x 55 cm)
RUNNING SURFACE	60in x 22in (152cm x 55cm)
INCLINE RANGE	0-15% max incline
SPEED RANGE	0.5 - 12.5 mph (0.5 - 20 kmh)
STEP-UP HEIGHT	7 in (17.8 cm)
PRODUCT WEIGHT	370 lb (168 kg)

**Light commercial rated*



THE HARDEST WORKOUT IN THE GYM JUST GOT HARDER.

The StairMaster 10G marks a revolutionary shift in stair-climbing technology. The innovative new design features the OverDrive Training Mode that simulates carrying or pushing a load up stairs, for the most intense climbing workout. The 10G's advancements all focus on delivering the best climbing experience ever created. User-focused features include the widest and deepest stepping surface and lowest step-up height in the industry, ergonomic handrails to support multiple climbing positions and an all new drive train that delivers smooth, quiet performance.

StairMaster 10G

DIMENSIONS	63 x 34 x 81in (160 x 86 x 206cm)
STEP SURFACE	12in (30cm) Deep x 22in (56cm) Width
STEP HEIGHT	8in (20cm)
STEP RATE	25 Levels ranging from 24-190 steps per minute
RECOMMENDED CEILING HEIGHT	10ft (3.05m)
STEP-UP HEIGHT	9in (23cm)
PRODUCT WEIGHT	615 lbs (279kg)

FEATURES:

Intense OverDrive Training Mode: Boost cardio intensity with the OverDrive Training Mode simulating the ultimate workout challenge with Sled Push and Farmer's Carry exercises up stairs for advanced endurance training.
 Landmark Challenge
 Wireless phone charger
 Apple + Samsung watch tap to pair for data tracking
 Cup Holders



StairMaster 8Gx

DIMENSIONS	58 x 34 x 79in (147 x 86 x 200cm)
STEP SURFACE	10in (25cm) Deep x 22in (56cm) Width
STEP HEIGHT	8in (20cm)
STEP RATE	20 Levels ranging from 24-162 steps per minute
RECOMMENDED CEILING HEIGHT	10ft (3.05m)
STEP-UP HEIGHT	9in (23cm)
PRODUCT WEIGHT	509.4lbs (231.1kg)

FEATURES:

Landmark Challenge
 Wireless phone charger
 Apple + Samsung watch tap to pair for data tracking
 Cup Holders



StairMaster 4G

DIMENSIONS	54 x 29 x 64 in (137 x 74 x 64cm)
STEP SURFACE	10 in x 18in (27cm x 46cm)
RECOMMENDED CEILING HEIGHT	8ft (2.44m)
STEP UP HEIGHT	14 in (35.5cm) to first flat step
PRODUCT WEIGHT	348 lbs (158kg)

**Light commercial rated*

FEATURES:

Landmark Challenge
 Apple + Samsung watch tap to pair for data tracking
 Cup Holders



StairMaster 8FC

DIMENSIONS	43 x 27 x 68in (110 x 69 x 173cm)
STEP SURFACE	SoftTrac® cushion technology
STEP HEIGHT	1 to 14in (2.5 to 36cm)
STEP RATE	20 Levels ranging from 24-162 steps per minute
PRODUCT WEIGHT	188.2 lbs (85.4 kg)

FEATURES:

Landmark Challenge
 Wireless phone charger
 Apple + Samsung watch tap to pair for data tracking
 Cup Holders



Stairway GTL

DIMENSIONS	54 x 30.5 x 75.5 in (137 x 77 x 192 cm)
PRODUCT WEIGHT	300lb (136kg)
RECOMMENDED CEILING HEIGHT	8.5 ft (259cm)

FEATURES:

Closed-loop control for consistent speed
 Smooth, stable stepping motion
 Compact footprint with full-size performance
 Simple, user-friendly design

CARDIO

Climbing



StairMaster JLX

DIMENSIONS	79 x 30" x 71 in (201 x 76 x 180 cm) 37" (94 cm) *With Removable Cupholders Attached
CLIMBING ANGLE	40°
RECOMMENDED CEILING HEIGHT	8.5 ft (259 cm)
PRODUCT WEIGHT	344 lb (156 kg)



StairMaster Jacobs Ladder

DIMENSIONS	77 x 27 x 66 in (196 x 69 x 168 cm)
CLIMBING ANGLE	40°
RECOMMENDED CEILING HEIGHT	7.5ft (229cm)
PRODUCT WEIGHT	282 lb (128 kg)



StairMaster JL2

DIMENSIONS	77 x 27 x 66 in (196 x 69 x 168 cm)
CLIMBING ANGLE	40°
RECOMMENDED CEILING HEIGHT	7.5ft (229cm)
PRODUCT WEIGHT	280 lb (127 kg)

**Light commercial rated*

Ellipticals



Star Trac Climb Elliptical 8CE

DIMENSIONS	86 x 36 x 7 3in (219 x 91 x 185 cm)
INCLINE RANGE	0 - 20% max incline
STEP-UP HEIGHT	11 in (28 cm)
MOVEMENT ARMS	Option of ordering with Movement Arms or Fixed Arms
PRODUCT WEIGHT	320 lb (145 kg)

FEATURES:

Wireless phone charger
Apple + Samsung watch tap to pair for data tracking
Cup Holders



Star Trac Rear Drive Elliptical 8RDE

DIMENSIONS	86 x 36 x 7 3in (219 x 91 x 185 cm)
STRIDE LENGTH	Fixed, 18 in (48 cm)
STEP-UP HEIGHT	11 in (28 cm)
MOVEMENT ARMS	Articulating
PRODUCT WEIGHT	320 lb (145 kg)

FEATURES:

Wireless phone charger
Apple + Samsung watch tap to pair for data tracking
Cup Holders



Star Trac Cross Trainer 8CT

DIMENSIONS	76 x 30 x 72 in (193 x 76 x 182cm)
STRIDE LENGTH	Fixed, 18 in (48 cm)
STEP-UP HEIGHT	11 in (28 cm)
MOVEMENT ARMS	Articulating
PRODUCT WEIGHT	365 lb (165.6 kg)

FEATURES:

Wireless phone charger
Apple + Samsung watch tap to pair for data tracking
Cup Holders



Star Trac VersaStrider™ 8VS

DIMENSIONS	89 x 35 x 69 in (226 x 89 x 175 cm)
STRIDE LENGTH	Dynamic Variable, 10-32 in (25-81cm)
STEP-UP HEIGHT	11 in (28 cm)
MOVEMENT ARMS	Converging movement arms with multiple hand grip options
PRODUCT WEIGHT	590.8 lb (268 kg)

FEATURES:

Wireless phone charger
Apple + Samsung watch tap to pair for data tracking
Cup Holders

CARDIO

Ellipticals



Star Trac Cross Trainer 6CT

DIMENSIONS	76in x 30in x 64in (193cm x 76cm x 163cm)
STRIDE LENGTH	Fixed, 20in (51cm)
MOVEMENT ARMS	Articulating
PRODUCT WEIGHT	273lbs (124 kg)

FEATURES:

- Wireless phone charger
- Apple + Samsung watch tap to pair for data tracking
- Cup Holders



Star Trac Cross Trainer 4CT

DIMENSIONS	76 x 30 x 64 in (193 x 76 x 163 cm)
STRIDE LENGTH	20in (51cm)
MOVEMENT ARMS	Standard upright design
PRODUCT WEIGHT	273 lb (124 kg)

**Light commercial rated*



Star Trac Cross Trainer SCTx

DIMENSIONS	76 x 30 x 72 in (193 x 76 x 183 cm)
STRIDE LENGTH	18in (48cm)
MOVEMENT ARMS	Standard upright design
PRODUCT WEIGHT	337 lb (153 kg)

Upright & Recumbent Bikes



Star Trac Upright Bike 8UB

DIMENSIONS	46 x 25 x 63 in (117 x 64 x 160 cm)
PEDALS	One-sided, self-leveling platform with removable ratcheting strap
PEDAL MOUNTING	Morse Taper
SEAT ADJUSTMENT	Seat Adjustment: Easy up ratcheting seat for ease of use, 13 positions
PRODUCT WEIGHT	150.8 lbs (68.5 kg)

FEATURES:

- Wireless phone charger
- Apple + Samsung watch tap to pair for data tracking
- Cup Holders



Star Trac Upright Bike SUBx

DIMENSIONS	46 x 23 x 57 in (117 x 58 x 145 cm)
PEDALS	One-sided, self-leveling platform with removable ratcheting strap
SEAT ADJUSTMENT	Easy up ratcheting seat for ease of use
PRODUCT WEIGHT	141 lb (64 kg)



Star Trac Recumbent Bike 8RB

DIMENSIONS	65 x 28 x 60 in (164 x 71 x 151 cm)
PEDALS	One-sided, self-leveling platform with removable ratcheting strap
PEDAL MOUNTING	Morse Taper
SEAT ADJUSTMENT	Wrap around adjustment bar for ease of use. 12 positions, 12" (30cm) of slide adjustability
PRODUCT WEIGHT	208 lbs (94.4 kg)

FEATURES:

- Wireless phone charger
- Apple + Samsung watch tap to pair for data tracking
- Cup Holders



Star Trac Recumbent Bike SRBx

DIMENSIONS	66 x 26 x 53 in (168 x 66 x 135 cm)
PEDALS	One-sided, self-leveling platform with removable ratcheting strap
SEAT ADJUSTMENT	Wrap around adjustment bar for ease of use
PRODUCT WEIGHT	185 lb (84 kg)

CARDIO

Upright & Recumbent Bikes.



Star Trac Upright Bike 6UB

DIMENSIONS	46 x 23 x 57 in (117 x 58 x 145 cm)
PEDALS	One-sided, self-leveling platform with removable ratcheting strap
SEAT ADJUSTMENT	Easy up ratcheting seat for ease of use
PRODUCT WEIGHT	141 lb (64 kg)

FEATURES:

Wireless phone charger
Apple + Samsung watch tap to pair for data tracking
Cup Holders



Star Trac Upright Bike 4UB

WIDTH	46 x 57 x 23 in (117 x 45 x 58 cm)
PEDALS	One-sided, self-leveling platform with removable ratcheting strap
SEAT ADJUSTMENT	Pop Pin
PRODUCT WEIGHT	132 lb (60 kg)

**Light commercial rated*



Star Trac Recumbent Bike 6RB

DIMENSIONS	68 x 23 x 54 in (172 x 58 x 137 cm)
PEDALS	One-sided, self-leveling platform with removable ratcheting strap
SEAT ADJUSTMENT	Wrap around adjustment bar for ease of use
PRODUCT WEIGHT	186 lb (84 kg)

FEATURES:

Wireless phone charger
Apple + Samsung watch tap to pair for data tracking
Cup Holders

Star Trac Recumbent Bike 4RB

DIMENSIONS	68 x 23 x 54 in (172 x 58 x 137 cm)
PEDALS	One-sided, self-leveling platform with removable ratcheting strap
SEAT ADJUSTMENT	Wrap around adjustment bar for ease of use
PRODUCT WEIGHT	186 lb (84 kg)

**Light commercial rated*

Virtual Bike

FEATURED PARTNER



Virtual Bike -VB

The Star Trac Virtual Bike combines the state-of-the-art commercial grade group cycle built with a 21" touchscreen display to create the ultimate cycling workout experience.

The Virtual Bike is purpose-built to withstand the rigors of a commercial cardio floor and meet the needs of non-staffed vertical market spaces such as hospitality and multi-housing.

DIMENSIONS	53 x 21 x 62 in (135 x 53 x 158 cm)
PEDALS	Morse Taper Double Link - SPD and Athletic Shoe Cage
SEAT ADJUSTMENT	Pop Pin
PRODUCT WEIGHT	176 lbs (80 kg)

FEATURES:

Subscription-free cycling content library
Star Trac cooling fan
integrated apps, streaming, social media, news, and more!

CARDIO

Connected Performance



OPENHUB™: THE ULTIMATE PLATFORM

OpenHub isn't just a product—it's an ideology, redefining how we approach and integrate technology. As we developed OpenHub, one key insight guided our philosophy: with the vast range of potential solutions that technology can offer, no SINGLE company can be the expert in all of them. This realization led us to a simple but powerful approach: deliver world-class technology solutions by partnering with experts.

The result is the Star Trac and StairMaster OpenHub display family, designed to deliver both convenience and connectivity. These displays seamlessly combine functional design with advanced technology, allowing users to integrate their personal devices into their workout experience. Features like wireless charging, tap-to-pair connectivity, Bluetooth, and screen mirroring empower users to customize their workout to their preferences. Built on a completely open platform, OpenHub ensures compatibility with a wide range of connectivity options—including Bluetooth, Wi-Fi, HDMI, NFC, RFID, and ANT+—making it adaptable to the needs of any facility.

Our partnership with industry leaders ensures cutting-edge solutions in areas such as workout data tracking, interactive apps, IPTV, asset management, streaming media, wireless audio receivers, and add-on PVS systems. With OpenHub, you get the best of both worlds: advanced features to enhance user experiences and robust tools to support your business operations.

At the heart of OpenHub is our commitment to staying relevant in an ever-evolving technological landscape. We believe in future-proofing through adaptability, ensuring our solutions not only meet today's needs but are also prepared for tomorrow's opportunities. By collaborating with expert partners like Apple and Samsung, we deliver features such as tap-to-pair technology and wireless phone mirroring, empowering gym owners to offer modern, personalized experiences that resonate with their members.

Whatever you're looking for in technology—whether it's seamless integration, advanced entertainment, or efficient facility management—OpenHub is here to support you and your business; now and into the future.

OUR EXPERT PARTNERS MAKE OPENHUB... OPENHUB

TO HIGHLIGHT A FEW...

RUNTV

Standard on all Star Trac and StairMaster embedded displays, RunTV transforms your workout into an inspiring and engaging experience. Explore a curated collection of virtual environments that let you run through breathtaking landscapes or tackle iconic routes like the Tour de France. Stay motivated with empowering content, from technique-improving videos and stories of extraordinary human achievements to feature films that help you escape into your workout. Whatever inspires you, RunTV delivers personalized entertainment to keep you motivated and empowered on your fitness journey.

APPLE WATCH AND SAMSUNG GALAXY PAIRING

Experience seamless integration with our OpenHub display family, offering effortless tap-to-pair connectivity with Apple® and Samsung® smartwatches. This NFC technology enables real-time workout data sharing, empowering you to personalize and enhance your fitness journey. Available on all 8/10 Series displays, and our 4 series embedded display.

ECOFIT ASSET MANAGEMENT SOLUTIONS

Ecofit provides powerful tools to track equipment usage, schedule preventive maintenance, and access detailed analytics through an intuitive platform. By optimizing performance and extending asset lifespans, Ecofit helps facility owners enhance efficiency and improve member satisfaction.

20 MINUTE HIIT

The OpenHub™ embedded consoles feature a HIIT programs developed by World Record Holder and Master instructor Sonja Friend-Uhl. Designed for maximum efficiency, this 20-minute workout adapts to all fitness levels, delivering the proven benefits of interval training—reducing body fat, blood pressure, and glucose sensitivity while improving aerobic fitness and muscular power. Each piece of cardio equipment offers a unique version of the program, with hundreds of workout variations to keep users engaged as they progress. Achieve maximum results with 90% less training volume and up to 67% less time than traditional interval training.



OUR EXPERT PARTNERS



CARDIO

Connected Performance



A new era of cardio displays is here. The 8 and 10 Series introduce a sleek, modern, and sophisticated design, seamlessly blending cutting-edge technology with an intuitive user experience. Engineered for clarity and performance, these displays elevate workouts with stunning visuals, effortless navigation, and seamless connectivity—setting a new standard for cardio innovation.

A few of our favorite features....

PERSONAL DEVICE MIRRORING

Our 8 and 10 Series Apex Touchscreen displays now have wireless screen mirroring. Users can seamlessly stream their favorite content directly from their personal device – whether it’s YouTube, training apps or custom workout programs, this feature keeps workouts engaging and personal.

QUICK KEY SELECTION

Quickly adjust speed, incline, resistance and level with easy Quick Key buttons on all displays in the 8 and 10 series line. This user-friendly feature allows for easy adjustment to their workout while in motion. While benefiting all users, Quick Key controls are especially ideal for HIIT and performance training, they allow instant transitions with a SINGLE touch so users can move seamlessly between intervals.

CONNECTED CONSOLES

Over-the-air (OTA) updates are a key differentiator for the 10 and 8 Series, ensuring that when connected, facilities stay ahead with the latest features, integrations, and performance enhancements—without the hassle of manual updates.

APEX CARDIO DISPLAYS 8/10 SERIES



16 in/24 in Apex HD Touchscreen Display



Apex LED Display

Product Compatibility	24 in Apex Touchscreen - Treadmills 16 in Apex Touchscreen - Bikes, Ellipticals, Stepmills, Stepper	8 & 10 Series - Treadmills, Bikes, Ellipticals, Stepmills and Stepper
Multi-language options	22 Languages	12 Languages
20 Minute HIIT Programs	Yes	-
Pre-programmable Workouts	Yes, 20+ including HIIT20, Custom intervals, Set a Goal, HR Training, RunTV Scenic routes & more	Yes, 14+ Fitness Tests, Military Tests, CPAT, HR and Watts training, Random Hill, Landmark Challenge & more* *Workout program list varies by product type
Quick Keys	Yes, customizable	Yes
Quick start options	Yes, SINGLE button start options	Yes, SINGLE button start options
Integrated Fan	Yes, programmable auto start	Yes, programmable auto start
Connectivity & On-Board Entertainment		
Ethernet and WiFi enabled	Yes	Wifi only
Over the Air (OTA) Updates Internet connection required	Yes	Yes
Onboard Entertainment: integrated Apps, RunTV, Wireless Screen Mirroring + Casting	Yes	-
Apple GymKit & Samsung Galaxy Watch Tap-to-Pair	Yes	Yes
Bluetooth Data Tracking & App Connectivity	Yes	Yes
Bluetooth Audio	Yes	-
Bluetooth Heart Rate	Yes	No
Wireless Phone Charging	Yes	Yes
USB Ports	Yes, integrated USB-A and USB-C ports for device charging and manual software updates: cables not included.	Yes, integrated USB-A and USB-C ports for device charging and manual software updates: cables not included
External Media Compatibility		
TV tuner enabled Digital scanning only	Yes, add-on Tuner kit required (Global Tuner Options) ATSC, ISDB-T, DTMB, DVB-T2+C	-
Pro:Idiom	Yes, with add-on Tuner Kit* or by set top box *Future Feature	Yes, with PVS kit addition
IPTV	Yes, onboard app	Yes, with PVS kit and additional accessories
Set Top Box Compatible	Yes	Yes
PVS	-	Optional add-on kit
800/900 mHz receiver	-	Optional add-on kit
Partner Solutions		
EGYM 5 Star	Yes	-
Asset management	Ecofit Optional	Ecofit Optional

CARDIO

Connected Performance



APEX CARDIO DISPLAYS 6 SERIES



Apex 24 in or 16 in Touchscreen Display



Apex LED Display



Apex LCD+

Product Compatibility	24 in Apex Touchscreen - Treadmill 16 in Apex Touchscreen - All 6 Series	All 6 Series	All 6 Series
Multi-language options	22+ Languages	12 Languages	11 Languages
HIIT Programming	Innovative HIIT programming developed by our Master Instructors. Workouts are all 20 minutes, with variations that allow for hundreds of different workout combinations.	-	-
Pre-programmable Workouts	Yes, 20+ including HIIT20, Custom Intervals, Set a Goal, HR Training, RunTV Scenic routes & more	Yes, 14+ Fitness Tests, Military Tests, CPAT, HR and Watts training, Random Hill, Landmark Challenge & more* *Workout program list varies by product type	Yes, 14+ Fitness Tests, Military Tests, CPAT, HR and Watts training, Random Hill, Landmark Challenge & more* *Workout program list varies by product type
Quick Keys	Yes, customizable	Yes	Yes
Quick start options	Yes, single button start options	Yes, single button start options	Yes, single button start options
Integrated Fan	Yes, programmable auto start	Yes, programmable auto start	Yes, programmable auto start
Connectivity & On-Board Entertainment			
Ethernet and WiFi enabled	Yes	WiFi only	WiFi only
Over the Air (OTA) Updates Internet connection required	Yes	Yes	Yes
Onboard Entertainment: Integrated Apps, RunTV, Wireless Screen Mirroring + Casting	Yes	-	-
Apple GymKit & Samsung Galaxy Watch Tap-to-Pair	Yes	Yes	-
Bluetooth Data Tracking & App Connectivity	Yes	Yes	Yes
Bluetooth Audio, Heart Rate	Yes	-	-
Wireless Phone Charging	Yes	Yes	Yes
USB Ports	Yes, integrated USB-A and USB-C ports for device charging and manual software updates: cables not included	Yes, integrated USB-A and USB-C ports for device charging and manual software updates: cables not included	Yes, integrated USB-A and USB-C ports for device charging and manual software updates: cables not included
Wired Audio	Yes, by USB-C only	-	-
HDMI Personal Device Screen Mirroring	Yes; cables not included	Yes, with PVS addition; cables not included	Yes, with PVS addition; cables not included
External Media Compatibility			
TV tuner enabled -Digital scanning only	Yes, add-on Tuner kit required (Global Tuner Options) ATSC, ISDB-T, DTMB, DVB-T2+C	-	-
Pro:Idiom	Yes, with add-on Tuner Kit or by set top box	Yes, with PVS kit addition	Yes, with PVS kit addition
IPTV	Yes, onboard app	Yes, with PVS kit and additional accessories	Yes, with PVS kit and additional accessories
Set Top Box Compatible	Yes	Yes	Yes, with PVS kit and additional accessories
PVS	-	Optional add-on kit	Optional add-on kit
800/900 mHz receiver	-	Optional add-on kit	Not compatible with 800/900 mhz
Partner Solutions			
EGYM 5 Star	Yes	-	-
Asset management	Ecofit Optional	Ecofit Optional	-

CARDIO

Connected Performance

4-Series

The Star Trac 4 Series cardio line is a versatile and reliable light commercial product line designed to meet the unique needs of hospitality, multi-unit housing, and boutique fitness facilities. Combining sleek design with durable performance, the 4 Series offers smaller spaces the quality and functionality typically found in full commercial equipment. Featuring premium display options, Quick Key buttons, and the option for a personal viewing screen, this line provides an enhanced user experience while maintaining space efficiency. Whether outfitting a hotel gym, apartment complex, or specialized fitness studio, the 4 Series delivers a professional-grade solution tailored for light commercial environments.



CARDIO DISPLAYS 4 SERIES



16 in Touchscreen*
*Available Q2 2026



10 in Touchscreen



10 in Non-Touchscreen

Display Type	Apex G2 16in Touch	Apex G1 10in Touch	Apex G1 LCD
Multi-language options	20 Languages	12 Languages	
Pre-programmable work outs	Yes, 20+	Yes, 14+	
Quick start options	Yes, Single button start options	Yes, Single button start options	
Connectivity & On-Board Entertainment			
Ethernet And Wifi Enabled	Yes	-	
Over The Air (Ota) Updates Internet Connection Required	Yes	-	
Integrated Apps	Yes	-	
Wireless Screen Mirroring & Casting	Yes	-	
Runtv	Yes; Scenic Routes, Instructor-led Videos & more	-	
Apple Gymkit & Samsung Galaxy Watch Tap-To-Pair	Yes	-	
Bluetooth Data Tracking & App Connectivity	Yes	-	
Bluetooth Audio, Heart Rate	Yes	-	
Usb Ports	Yes, integrated USB-A and USB-C ports for device charging and manual software updates; cables not included	USB-a port for software updates and device charging; cables not included	
Wired Audio	Yes, by USB-C only	-	
Hdmi Personal Device Screen Mirroring	Yes; cables not included	-	
Tablet Holder	Integrated shelf on front of display	Integrated shelf on front of display, or option to mount tablet holder accessory	
External Media Compatibility			
TV tuner enabled, Digital Scanning Only	Yes (Global TV tuner options)	-	
Pro:Idiom	Yes, with add-on Tuner Kit or by set top box	Yes, with PVS kit addition	
IPTV/Set Top Box Compatible	Yes, onboard app	Yes, with PVS, add-on accessories required	
PVS	-	Optional	
Partner Solutions			
EGYM 5 Star	Yes	-	
Asset management	Ecofit Optional	-	

GROUP EX

Schwinn and Throwdown bring innovation and expertise to group exercise, offering authentic, high-quality equipment for dynamic and effective workouts. Schwinn, with its historic roots in outdoor cycling, brings the road feel indoors with unmatched quality and a commitment to advancing indoor cycling through comprehensive education and information.

For high-intensity training, Throwdown leads the way, elevating HIIT workouts with a versatile, space-efficient line of equipment, including the HIITMillX, HIIT Rower, HIIT Bike, HIIT Rope, HIIT Ski, and HIIT UBE; pair these with our BoxMaster, StairMaster 10G, or Throwdown Rigs to create a complete, high-energy HIIT circuit designed to challenge and engage users.



HIIT	28
GROUP CYCLING	34

GROUP EX

Throwdown - HIIT



HIITMill® X 9-4880

LENGTH	78 in (197 cm)
WIDTH	55 in (140 cm)
HEIGHT	66 in (167 cm)
RUNNING AREA	23 in Wide
STEP-ON HEIGHT	7.5 in (19 cm)
MAX USER WEIGHT	350 lb (159 kg)
MACHINE WEIGHT	441 lb (220 kg)



HIIT Bike 9-4860

LENGTH	51 in (130 cm)
WIDTH	29 in (74 cm)
HEIGHT	58 in (147 cm)
MAX USER WEIGHT	350 lb (159 kg)
USER HEIGHT RANGE	4 ft 11 in to 6 ft 8 in (150 to 203 cm)
MACHINE WEIGHT	146 lb (66 kg)



HIIT UBE 9-4840

LENGTH	70 in (178 cm)
LENGTH WITHOUT RAMP	48 in (121 cm)
WIDTH	36 in (92 cm)
HEIGHT	Up to 73 in (178 cm)
MAX USER WEIGHT	350 lb (159 kg)
MACHINE WEIGHT	320 lb (145 kg)

OPTIONAL



RAMP 718-5637-26



HIIT Rower 9-4850

LENGTH	96 in (244 cm)
WIDTH	26.5 in (68 cm)
SEAT HEIGHT	14 in (35 cm)
MAX USER WEIGHT	350 lbs (159kg)
MACHINE WEIGHT	82 lb (37 kg)



**Product featured with optional platform*

HIIT SKI 9-4890

LENGTH	85 in (216 cm)
WIDTH	20 in (52 cm)
DEPTH	16 in (40 cm)
MAX USER WEIGHT	350 lbs (159kg)
MACHINE WEIGHT	52 lbs (23 kg)

OPTIONAL



PLATFORM 716-0176

GROUP EX

HIIT Console



DISPLAY TYPE	Fixed Segment and Dot Matrix LCD
DISPLAY AREA	14.5 in
BACKLIGHT	Yes
# METRICS DISPLAYED	5
# PROGRAMS	5
CUSTOM PROGRAMS	5 (Time, Distance, Calories, Time interval, Calorie interval)
POWER REQUIREMENT	Power 4x AA batteries
5 GHZ HEART RATE	Yes
ANT+ HEART RATE	Yes
ANT+ L. BOARD SIGNAL	Yes
BLE CONNECTIVITY	Yes
MULTI-LANGUAGE OPTIONS	No
QUICK START OPTIONS	Yes
BLUETOOTH DATA TRACKING	Yes
USB SOFTWARE UPLOAD	Yes



HIIT Rope TD-RPT01

LENGTH	22 in (55.8 cm)
WIDTH	8.2 in (20.7 cm)
HEIGHT	16 in (40.6 cm)
RESISTANCE LEVELS	6 levels of resistance
MACHINE WEIGHT	41.7 lb (18.9 kg)

*Product shown with optional external pulley

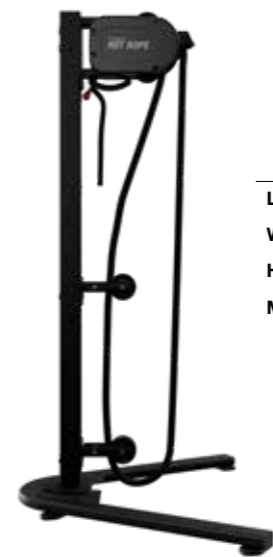

Freestand 9-TD-RPT-S

LENGTH	92 in (234 cm)
WIDTH	63 in (160 cm)
HEIGHT	45 in (114 cm)
MACHINE WEIGHT	142 lb (64 kg)



External Pulley 73-00293

LENGTH	10.8 in (27.5 cm)
WIDTH	7.5 in (19 cm)
HEIGHT	6.1 in (15.5 cm)
MACHINE WEIGHT	8.8 lb (3.8 kg)

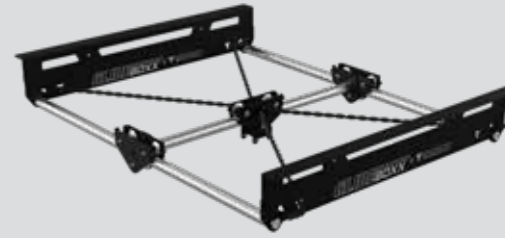

The GlideBoxx turns your punching bag into an active opponent by allowing the bag to react to your strikes and coming back at you forcing you to train footwork and angles in a realistic way. Great for Boxing, Muay Thai, MMA, and Kickboxing.

Glideboxx 9-TD-GBX3-XX

WIDTH	74 in (188 cm)
DEPTH	56 in (142 cm)
HEIGHT	14 in (37 cm)
MACHINE WEIGHT	153 lbs (69 kg)

COMPATIBLE WITH 9 FBR.
FOR MORE INFORMATION SEE PAGE 104

GROUP EX

Schwinn



Aetherion S/R Bike
9-7600/9-7610

WIDTH	24 IN (61 CM)
LENGTH	58 IN (147 CM)
HEIGHT	37.8 IN (96 CM)
PRODUCT WEIGHT	147.5 LB (66.9 KG)



Aetherion+ S/R Bike
9-7602/9-7612

WIDTH	24 IN (61 CM)
LENGTH	58 IN (147 CM)
HEIGHT	37.8 IN (96 CM)
PRODUCT WEIGHT	149.7 LB (69 KG)

GROUP EX

Schwinn



AC Sport 9-7340

WIDTH	20" (51 CM)
LENGTH	50" (127 CM)
HEIGHT	50" (127 CM)
PRODUCT WEIGHT	134 LB (61 KG)



SC5 9-7410

WIDTH	21" (53 CM)
LENGTH	55" (140 CM)
HEIGHT	46" (117 CM)
PRODUCT WEIGHT	134 LB (61 KG)



IC CLASSIC 9-7420

WIDTH	20" (51 CM)
LENGTH	43.5" (110 CM)
HEIGHT	46" (117 CM)
PRODUCT WEIGHT	114 LB (52 KG)

ADD-ON CONSOLE OPTIONS



Echelon2 (Power)
740-8941 - AC Performance
740-8942 - AC Sport



Echelon2 (No Power)
740-8727 - AC Performance, no Power
740-8940 - AC Sport, no Power



Cadence Pro
740-8803 - AC Sport
700-0008 - SC5 & IC Classic



TRIPLE LINK PEDALS

Triple Link pedals give users the freedom to choose between strapping in with the use of toe cages or using cycling shoes with pedal options for SPD® & Keo or SPD & Delta® compatible clips. Our pedals use a patent-pending threadless spindle that virtually eliminates the potential for the pedal spindle to break or back out of the crank. With easy installation and worry-free performance, we think it's the best thing to happen to pedals since the clip.

GROUP EX

Zone Console



SCHWINN ZONE CONSOLE + ION POWER METER

Group Cycling unites a diverse array of people seeking an elevated level of training and motivation. Our Zone Console is uniquely qualified to meet the challenge. Powered by Schwinn Zone Training, instructors will love uniting a class with color, allowing members at both ends of the fitness spectrum to ride side by side with the same intensity, sense of accomplishment.

The Zone Console brings the power of performance data and instructor creativity together in one seamless system. Now hardwired directly to the Schwinn Ion Power Meter, this integrated design delivers clean, interference-free data with every ride. No Bluetooth dropouts, no interruptions, just consistent accuracy riders can trust.

Built for today's studios, the Zone Console turns metrics into motivation through vivid colors, intuitive graphics, and performance tracking tools that keep both instructors and riders fully engaged. Instructors can design immersive, data-driven classes featuring FTP trophies, fusion timers, and customized display layouts; expanding programming possibilities for every fitness community.

As part of the OpenHub™ family, the Zone Console makes connectivity simple while unlocking a world of compatibility with leading fitness platforms. Whether you're elevating your studio experience or building measurable training programs, Schwinn delivers the reliability, precision, and innovation to keep your members inspired and progressing ride after ride.

Highlights:

- Direct, hardwired integration with Schwinn Ion Power Meter for unmatched accuracy
- Stable, real-time performance data with no wireless interference
- Immersive color feedback and dynamic metric displays
- FTP trophies and fusion timers for tracking progress and creativity
- Engineered for commercial reliability and seamless OpenHub™ connectivity



The Ion Powermeter is hardwired into the Zone Console, no bluetooth or ANT+ needed between them.

STRENGTH

With the invention of strength training machines, Nautilus brought fitness to the masses by focusing on biomechanics that complement natural human movements, making weightlifting accessible for everyone. This approach to authentic, inclusive muscle-building has influenced strength training programs globally for over 50 years. Today, Throwdown builds on this legacy by offering versatile, high-performance strength equipment designed to empower individuals at any fitness level. Together, Nautilus and Throwdown continue to make strength accessible and engaging, supporting a lifetime of fitness

 **NAUTILUS**

 **THROWDOWN**



 **NAUTILUS**

STRENGTH

Nautilus

Inspiration

The inspiration Strength Line embodies the innovation that redefined strength training. With sleek, modern aesthetics and uniform towers, this line makes a striking first impression in any commercial fitness space.

Every machine is engineered to mirror natural movement, delivering an intuitive, biomechanically precise workout. Users will appreciate the effortless functionality—featuring our patented Lock N Load weight selection system, wrap-around assisted seat adjustment, lenticular image placards, and pre-stretch and range of motion controls. Built for performance and accessibility, Nautilus inspiration Strength enhances the training experience for all.



Pull Over
IPPO5

WIDTH	58 in (147 cm)
LENGTH	58 in (147 cm)
HEIGHT	64 in (163 cm)
STACK WEIGHT	200 lb (91 kg)
PRODUCT WEIGHT	693 lb (314 kg)



Shoulder Press
IPSP5

WIDTH	58 in (147 cm)
LENGTH	60 in (152 cm)
HEIGHT	64 in (163 cm)
STACK WEIGHT	200 LB (91 KG)
PRODUCT WEIGHT	609 LB (276 KG)



Pec Fly/ Rear Deltoid
IPPF5

WIDTH	58 in (147 cm)
LENGTH	46 in (117 cm)
HEIGHT	80 in (203 cm)
STACK WEIGHT	240 lb (109 kg)
PRODUCT WEIGHT	706 lb (320 kg)



Deltoid Raise
IPDR5

WIDTH	52 in (132 cm)
LENGTH	47 in (119 cm)
HEIGHT	64 in (163 cm)
STACK WEIGHT	200 lb (91 kg)
PRODUCT WEIGHT	618 lb (280 kg)



Lat Pull Down
IPPD5

WIDTH	55 in (140 cm)
LENGTH	55 in (140 cm)
HEIGHT	77 in (196 cm)
STACK WEIGHT	240 lb (109 kg)
PRODUCT WEIGHT	715 lb (324 kg)



Vertical Row
IPVR5

WIDTH	50 in (127 cm)
LENGTH	45 in (114 cm)
HEIGHT	77 in (196 cm)
STACK WEIGHT	240 lb (108 kg)
PRODUCT WEIGHT	690 lb (313 kg)



Chest Press
IPVP5

WIDTH	59 in (150 cm)
LENGTH	43 in (109 cm)
HEIGHT	76 in (193 cm)
STACK WEIGHT	240 lb (109 kg)
PRODUCT WEIGHT	664 lb (301 kg)



Biceps Curl
IPBC5

WIDTH	56 in (142 cm)
LENGTH	45 in (114 cm)
HEIGHT	64 in (163 cm)
STACK WEIGHT	200 lb (91 kg)
PRODUCT WEIGHT	613 lb (278 kg)



Bilateral Arm Curl
IPBA5

WIDTH	56 in (142 cm)
LENGTH	45 in (114 cm)
HEIGHT	64 in (163 cm)
STACK WEIGHT	200 lb (91 kg)
PRODUCT WEIGHT	618 lb (280 kg)



Tricep Dip
IPTD5

WIDTH	52 in (132 cm)
LENGTH	51 in (130 cm)
HEIGHT	64 in (163 cm)
STACK WEIGHT	240 lb (109 kg)
PRODUCT WEIGHT	750 lb (340 kg)

LOCK N LOAD® WEIGHT SELECTION SYSTEM



Nautilus selectorized strength has one of the most innovative and easy to use weight selection systems ever. Lock N Load® removes the need for pins, which can easily be lost or broken, meaning fewer maintenance headaches. Members will love the intuitive weight adjustment, which is as simple as flipping a switch.

STRENGTH

Nautilus - Inspiration



Dual Adjustable Pulley
NP-D9302

WIDTH	62 in (157 cm)
LENGTH	46 in (117 cm)
HEIGHT	88 in (224 cm)
STACK WEIGHT	2 x 400 lb (2 x 181 kg) 2 x 100 lb (at handle)
PRODUCT WEIGHT	1,308 lb (593 kg)



Tricep Extension
IPTE5

WIDTH	56 in (142 cm)
LENGTH	43 in (109 cm)
HEIGHT	64 in (163 cm)
STACK WEIGHT	200 lb (91 kg)
PRODUCT WEIGHT	620 lb (281 kg)



Leg Press
IPLP5

WIDTH	54 in (137 cm)
LENGTH	74 in (187 cm)
HEIGHT	64 in (163 cm)
STACK WEIGHT	400 lb (181 kg)
PRODUCT WEIGHT	1,120 lb (508 kg)



Leg Extension
IPLE5

WIDTH	48 in (122 cm)
LENGTH	53 in (135 cm)
HEIGHT	64 in (163 cm)
STACK WEIGHT	240 lb (109 kg)
PRODUCT WEIGHT	717 lb (325 kg)



Leg Curl
IPLC5

WIDTH	46 in (117 cm)
LENGTH	64 in (163 cm)
HEIGHT	64 in (163 cm)
STACK WEIGHT	240 lb (109 kg)
PRODUCT WEIGHT	743 lb (337 kg)



Abduction/ Adduction
IPAA5

WIDTH	55 in (140 cm)
LENGTH	56 in (142 cm)
HEIGHT	64 in (163 cm)
STACK WEIGHT	200 lb (91 kg)
PRODUCT WEIGHT	657 lb (298 kg)



Glute Press
IPGM5

WIDTH	45 in (114 cm)
LENGTH	75 in (191 cm)
HEIGHT	64 in (163 cm)
STACK WEIGHT	240 lb (109 kg)
PRODUCT WEIGHT	600 lb (272 kg)



Back Extension
IPBE5

WIDTH	51 in (130 cm)
LENGTH	50 in (127 cm)
HEIGHT	64 in (163 cm)
STACK WEIGHT	200 lb (91 kg)
PRODUCT WEIGHT	600 lb (272 kg)



Abdominal Crunch
IPAC5

WIDTH	52 in (132 cm)
LENGTH	51 in (130 cm)
HEIGHT	64 in (163 cm)
STACK WEIGHT	200 lb (91 kg)
PRODUCT WEIGHT	684 lb (310 kg)



Rotary Torso
IPRT5

WIDTH	58 in (147 cm)
LENGTH	34 in (86 cm)
HEIGHT	64 in (163 cm)
STACK WEIGHT	200 lb (91 kg)
PRODUCT WEIGHT	560 lb (254 kg)

STRENGTH

Nautilus

Impact

The Impact Strength line refines proven biomechanics with subtle yet powerful innovations, delivering a strength training experience built for performance. Designed for versatility, this line retains the key features that make every workout effective, including pre-stretch, start assist, range of motion selection, and graduated heavy weight stacks. Engineered for strength and durability, Impact Strength integrates advanced biomechanics with intuitive functionality, ensuring a seamless training experience. With a design that balances innovation and reliability, this line remains a trusted choice for diverse strength training environments.



Chest Press
9NA-S4301

WIDTH	52 in (132 cm)
LENGTH	50 in (127 cm)
HEIGHT	60 in (152 cm)
STACK WEIGHT	260 lb (130 kg)
PRODUCT WEIGHT	596 lb (270 kg)



Incline Press
9NA-S2301

WIDTH	51 in (130 cm)
LENGTH	75 in (191 cm)
HEIGHT	60 in (152 cm)
STACK WEIGHT	260 lb (130 kg)
PRODUCT WEIGHT	690 lb (313 kg)



Shoulder Press
9NA-S4307

WIDTH	53 in (135 cm)
LENGTH	64 in (163 cm)
HEIGHT	60 in (152 cm)
STACK WEIGHT	260 lb (130 kg)
PRODUCT WEIGHT	620 lb (281 kg)



Deltoid Fly
9NA-S4304

WIDTH	30 in (76 cm)
LENGTH	50 in (127 cm)
HEIGHT	79 in (201 cm)
STACK WEIGHT	220 lb (110 kg)
PRODUCT WEIGHT	580 lb (263 kg)



Deltoid Raise
9NA-S4302

WIDTH	46 in (117 cm)
LENGTH	51 in (130 cm)
HEIGHT	60 in (152 cm)
STACK WEIGHT	130 lb (65 kg)
PRODUCT WEIGHT	479 lb (217 kg)



Fixed Lat Pull Down
9NA-S3303

WIDTH	43 in (109 cm)
LENGTH	64 in (163 cm)
HEIGHT	80 in (203 cm)
STACK WEIGHT	260 lb (130 kg)
PRODUCT WEIGHT	673 lb (305 kg)



Lat Pull Down
9NA-S3305

WIDTH	55 in (140 cm)
LENGTH	47 in (119 cm)
HEIGHT	98 in (249 cm)
STACK WEIGHT	260 lb (130 kg)
PRODUCT WEIGHT	593 lb (269 kg)



Vertical Row
9NA-S3301

WIDTH	45 in (114 cm)
LENGTH	62 in (157 cm)
HEIGHT	60 in (152 cm)
STACK WEIGHT	260 lb (130 kg)
PRODUCT WEIGHT	598 lb (271 kg)

STRENGTH

Nautilus - Impact



Low Row
9NA-S3306

WIDTH	29 in (72 cm)
LENGTH	90 in (228.6 cm)
HEIGHT	86 in (218 cm)
STACK WEIGHT	260 lb (130 kgs)
PRODUCT WEIGHT	565 lb (256 kgs)



Chin Dip Assist
9NA-S6334

WIDTH	60 in (152 cm)
LENGTH	50 in (127 cm)
HEIGHT	91 in (231 cm)
STACK WEIGHT	200 lb (100 kg)
PRODUCT WEIGHT	776 lb (352 kg)



Biceps Curl
9NA-S5301

WIDTH	46 in (117 cm)
LENGTH	58 in (147 cm)
HEIGHT	60 in (152 cm)
STACK WEIGHT	180 lb (90 kg)
PRODUCT WEIGHT	545 lb (247 kg)



Tricep Extension
9NA-S5302

WIDTH	46 in (117 cm)
LENGTH	47 in (119 cm)
HEIGHT	60 in (152 cm)
STACK WEIGHT	180 lb (90 kg)
PRODUCT WEIGHT	499 lb (226 kg)



Dip Machine
9NA-S5303

WIDTH	42 in (107 cm)
LENGTH	55 in (140 cm)
HEIGHT	65 in (165 cm)
STACK WEIGHT	260 lb (130 kg)
PRODUCT WEIGHT	540 lb (245 kg)



Seated Leg Press
9NA-S1305

WIDTH	47 in (119 cm)
LENGTH	74 in (187 cm)
HEIGHT	65 in (165 cm)
STACK WEIGHT	360 lb (180 kg)
PRODUCT WEIGHT	968 lb (439 kg)



Seated Leg Curl
9NA-S1313

WIDTH	39 in (99 cm)
LENGTH	70 in (178 cm)
HEIGHT	60 in (152 cm)
STACK WEIGHT	260 lb (130 kg)
PRODUCT WEIGHT	664 lb (301 kgs)



Leg Extension
9NA-S1312

WIDTH	38 in (145 cm)
LENGTH	57 in (97 cm)
HEIGHT	60 in (152 cm)
STACK WEIGHT	260 lb (130 kg)
PRODUCT WEIGHT	609 lb (276 kg)



Leg Curl
9NA-S1301

WIDTH	38 in (97 cm)
LENGTH	71 in (180 cm)
HEIGHT	60 in (152 cm)
STACK WEIGHT	180 lb (90 kg)
PRODUCT WEIGHT	516 lb (234 kg)



Kneeling Leg Curl
9NA-S1311

WIDTH	44 in (112 cm)
LENGTH	51 in (130 cm)
HEIGHT	60 in (152 cm)
STACK WEIGHT	130 lb (65 kg)
PRODUCT WEIGHT	434 lb (197 kg)



Adductor
9NA-S1308

WIDTH	48 in (122 cm)
LENGTH	67.5 in (171 cm)
HEIGHT	60 in (152 cm)
STACK WEIGHT	180 lb (90 kg)
PRODUCT WEIGHT	523 lb (237 kg)



Abductor
9NA-S1307

WIDTH	48 in (122 cm)
LENGTH	67.5 in (171 cm)
HEIGHT	60 in (152 cm)
STACK WEIGHT	180 lb (90 kg)
PRODUCT WEIGHT	543 lb (237 kg)



Standing Calf
9NA-S1309

WIDTH	49 in (124 cm)
LENGTH	41 in (104 cm)
HEIGHT	62 in (151 cm)
STACK WEIGHT	260 lb (130 kg)
PRODUCT WEIGHT	635 lb (288 kg)



Low Back
9NA-S3302

WIDTH	46 in (117 cm)
LENGTH	53 in (135 cm)
HEIGHT	60 in (152 cm)
STACK WEIGHT	260 lb (130 kg)
PRODUCT WEIGHT	593 lb (269 kg)



Abdominal
9NA-S6301

WIDTH	43 in (109 cm)
LENGTH	59 in (150 cm)
HEIGHT	60 in (152 cm)
STACK WEIGHT	130 lb (65 kg)
PRODUCT WEIGHT	382 lb (173 kg)

STRENGTH

Nautilus

HumanSport

Inspired by the natural, fluid movements of the human body, HumanSport redefines functional strength training. Its intuitive, cable-based design provides a seamless, biomechanically sound workout experience that adapts to each user's unique motion. Seven dual-function machines deliver a complete, full-body training solution, maximizing space efficiency without compromising versatility. With an emphasis on user-friendly operation and progressive resistance, HumanSport offers an innovative approach to strength training that enhances performance, mobility, and overall fitness.



Freedom Trainer
HSFT3

WIDTH	75 in (191 cm) Arms Extended Left and Right 125 in (317 cm)
LENGTH	43 in (108 cm)
HEIGHT	72 in (182 cm) Arms Extended Vertically Up 92 in (234 cm)
STACK WEIGHT	2x 80 lb (2x 36 kg)
PRODUCT WEIGHT	1,100 lb (499 kg)



WHEELCHAIR ACCESSIBLE

3:1 cable ratio for low starting resistance

Open design allowing for wheelchair access

Easily adjustable, counter balanced pivot handles, even while in the seated position

Weight stack utilizes Lock N Load switch technology for quick and easy weight selection even while seated



Arm Crunch
HSAC3

WIDTH	39 in (99 cm)
LENGTH	43 in (109 cm)
HEIGHT	68 in (172 cm)
STACK WEIGHT	2x 88 lb (2x 40 kg)
PRODUCT WEIGHT	655 lb (298 kg)



WHEELCHAIR ACCESSIBLE

2:1 cable ratio for low starting resistance

Flat anti-skid plate that can be used to roll in a wheelchair

Adjustable stabilizer pad

Seat is eliminated allowing for wheelchair access

Accessory handles are optimally placed for easy access while in the seated position

Weight stack utilizes Lock N Load switch technology for quick and easy weight selection even while seated



Total Delts
HSTD3

WIDTH	29 in (74 cm)
LENGTH	78 in (198 cm)
HEIGHT	64 in (163 cm)
STACK WEIGHT	2x 88 lb (2x 40 kg)
PRODUCT WEIGHT	600 lb (273 kg)



WHEELCHAIR ACCESSIBLE

2:1 cable ratio for low starting resistance

Fold away seat to allow for wheelchair access

Accessory handles are optimally placed for easy access while in the seated position

Weight stack utilizes Lock N Load switch technology for quick and easy weight selection even while seated

STRENGTH

Nautilus - HumanSport



Lat Pulley
HSLP3

WIDTH	58 in (147 cm)
LENGTH	58 in (147 cm)
HEIGHT	83 in (211 cm)
STACK WEIGHT	2x 88 lb (2x 40 kg)
PRODUCT WEIGHT	655 lb (298 kg)



WHEELCHAIR ACCESSIBLE

- 2:1 cable ratio for low starting resistance
- Fold away seat to allow for wheelchair access
- Knee pad adjustment stabilizes users lifting heavy loads
- Accessory handles are optimally placed for easy access while in the seated position
- Weight stack utilizes Lock N Load switch technology for quick and easy weight selection even while seated



Shoulder Chest
HSSC3

WIDTH	63 in (160 cm)
LENGTH	45 in (114 cm)
HEIGHT	64 in (163 cm)
STACK WEIGHT	2x 88 lb (2x 40 kg)
PRODUCT WEIGHT	655 lb (298 kg)



WHEELCHAIR ACCESSIBLE

- 2:1 cable ratio for low starting resistance
- Fold away seat to allow for wheelchair access
- Accessory handles are optimally placed for easy access while in the seated position
- Weight stack utilizes Lock N Load switch technology for quick and easy weight selection even while seated



Pull Lift
HSPL3

WIDTH	39 in (99 cm)
LENGTH	78 in (198 cm)
HEIGHT	95 in (241 cm)
STACK WEIGHT	2x 88 lb (2x 40 kg)
PRODUCT WEIGHT	750 lb (341 kg)



Total Legs
HSTL3

WIDTH	39 in (99 cm)
LENGTH	64 in (163 cm)
HEIGHT	65 in (165 cm)
STACK WEIGHT	2x 88 lb (2x 40 kg)
PRODUCT WEIGHT	691 lb (314 kg)

STRENGTH

Nautilus

Leverage Elite

The pinnacle of biomechanics and design. Featuring four-bar linkage that replicates Nautilus' signature cam load curve, lighter where you're weakest, heaviest where you're strongest. With sleek aesthetics, low load points, and biomechanical precision, Elite is the gold standard of plate loaded strength. Think of it as the 10 Series of lifting: bold, refined, and built to lead.



Chest Press
9NP3-L2002

WIDTH	59 in (150 cm)
LENGTH	71 in (180 cm)
HEIGHT	58 in (147 cm)
PRODUCT WEIGHT	481 lb (218 kg)



Incline Press
9NP3-L2003

WIDTH	51 in (130 cm)
LENGTH	76 in (193 cm)
HEIGHT	51 in (130 cm)
PRODUCT WEIGHT	413 lb (187 kg)



Decline Press
9NP3-L2004

WIDTH	58 in (147 cm)
LENGTH	81 in (206 cm)
HEIGHT	49 in (124 cm)
PRODUCT WEIGHT	503 lb (228 kg)



Shoulder Press
9NP3-L4002

WIDTH	51 in (130 cm)
LENGTH	71 in (180 cm)
HEIGHT	58 in (147 cm)
PRODUCT WEIGHT	410 lb (186 kg)



Abdominal Crunch
9NP3-L5003

WIDTH	61 in (156 cm)
LENGTH	62 in (157 cm)
HEIGHT	61 in (156 cm)
PRODUCT WEIGHT	461 lb (209 kg)



Low Row
9NP3-L3004

WIDTH	51 in (130 cm)
LENGTH	79 in (201 cm)
HEIGHT	46 in (117 cm)
PRODUCT WEIGHT	426 lb (193 kg)



High Row
9NP3-L3005

WIDTH	51 in (130 cm)
LENGTH	86 in (218 cm)
HEIGHT	73 in (185 cm)
PRODUCT WEIGHT	443 lb (201 kg)



Lat Pull Down
9NP3-L3003

WIDTH	51 in (130 cm)
LENGTH	81 in (206 cm)
HEIGHT	80 in (203 cm)
PRODUCT WEIGHT	406 lb (184 kg)



Biceps Curl
9NP3-L5005

WIDTH	62 in (157 cm)
LENGTH	61 in (155 cm)
HEIGHT	41 in (104 cm)
PRODUCT WEIGHT	465 lb (211 kg)

STRENGTH

Nautilus

Leverage Premier

Performance-driven strength with a linear edge. Premier delivers consistent plate resistance through the full range of motion with a minimalist design and uncompromising feel. Built to blend seamlessly with Elite, these pieces balance advanced performance with durability. This is the 8 Series of plate loaded: straightforward, reliable, and engineered for lifters who demand full control.

STRENGTH



Freedom Rack®
NP-L8507

WIDTH	75 in (191 cm)
LENGTH	83 in (211 cm)
HEIGHT	90 in (229 cm)
PRODUCT WEIGHT	655 lb (297 kg)



Smith Machine
NP-L8500

WIDTH	89 in (226 cm)
LENGTH	67 in (170 cm)
HEIGHT	82 in (208 cm)
PRODUCT WEIGHT	648 lb (294 kg)



Glute Drive
NP-L1131

WIDTH	60 in (152.5 cm)
LENGTH	62 in (157.5 cm)
HEIGHT	35 in (89 cm)
PRODUCT WEIGHT	252 lb (114 kg)



Belt Squat
NP-L1132

WIDTH	43 in (110 cm)
LENGTH	72 in (182 cm)
HEIGHT	59 in (150 cm)
PRODUCT WEIGHT	397 lbs (180 kg)

STRENGTH

Leverage - Premier



Deadlift Shrug
NP-L3006

WIDTH	61 in (156 cm)
LENGTH	74 in (188 cm)
HEIGHT	31 in (79 cm)
PRODUCT WEIGHT	249 lb (113 kg)



Hack Squat
NP-L1130

WIDTH	72 in (182 cm)
LENGTH	93 in (236 cm)
HEIGHT	47 in (119 cm)
PRODUCT WEIGHT	446 lb (202 kg)



Standing Calf Raise
NP-L1112

WIDTH	73 in (186 cm)
LENGTH	42 in (110 cm)
HEIGHT	81 in (206 cm)
PRODUCT WEIGHT	463 lbs (210 kg)



Tilt Seat Calf
NP-L1110

WIDTH	27 in (69 cm)
LENGTH	58 in (147 cm)
HEIGHT	37 in (94 cm)
PRODUCT WEIGHT	170 lb (77 kg)



Pendulum Squat
9NP-L1143

WIDTH	95 in (241 cm)
LENGTH	56 in (142 cm)
HEIGHT	72 in (183 cm)
PRODUCT WEIGHT	485 lb (220 kg)



Power Squat
9NP-L1142

WIDTH	86 in (218 cm)
LENGTH	51 in (130 cm)
HEIGHT	56 in (142 cm)
PRODUCT WEIGHT	695 lb (315 kg)



Angled Leg Press
NP-L1141

WIDTH	72 in (182 cm)
LENGTH	90 in (229 cm)
HEIGHT	58 in (147 cm)
PRODUCT WEIGHT	569 lb (258 kg)



Incline Lever Row
NP-L3140

WIDTH	34 in (86 cm)
LENGTH	72 in (183 cm)
HEIGHT	49 in (124 cm)
PRODUCT WEIGHT	214 lb (97 kg)

STRENGTH

Nautilus

Multi-Stations

Today's fitness facilities demand smarter, more adaptable strength solutions. Whether you're optimizing a boutique space, outfitting a high-traffic gym, or designing a multi-use training zone, the Nautilus Multi-Station delivers unmatched versatility without compromising performance.

Built for efficiency and scalability, each Multi-Station seamlessly integrates key strength modalities, like the Lat Pulldown, Low Row, and Triceps Press, from our industry-leading lines into a compact footprint. Modular by design, it allows operators to configure the unit based on their space, member demographics, and training trends—ensuring a tailored solution that evolves with your facility's needs.



Cable Cross Over
9NP-M9201

WIDTH	158 in (401 cm)
LENGTH	34 in (86 cm)
HEIGHT	91 in (230 cm)
STACK WEIGHT	2 x 115.5 lb (2 x 52.2 kg)
PRODUCT WEIGHT	1010 lb (458 kg)



4 Station
9NP-M9601

WIDTH	75 in (190 cm)
LENGTH	152 in (387 cm)
HEIGHT	94 in (239 cm)
STACK WEIGHT	Lat Pull Down/Low Row 297 lb (135 kg) Triceps Press 231 lb (105 kg) Cross over 115.5 lb (52.5 kg)
PRODUCT WEIGHT	1689 lb (766 kg)



5 Station
9NP-M9605

WIDTH	200 in (508 cm)
LENGTH	152 in (387 cm)
HEIGHT	94 in (239 cm)
STACK WEIGHT	Lat Pull Down/Low Row 297 lb (135 kg) Triceps Press 231 lb (105 kg) Cross over 2 x 115.5 lb (2 x 52.5 kg)
PRODUCT WEIGHT	2350 lb (1066 kg)

STRENGTH

Nautilus - Multi-Stations

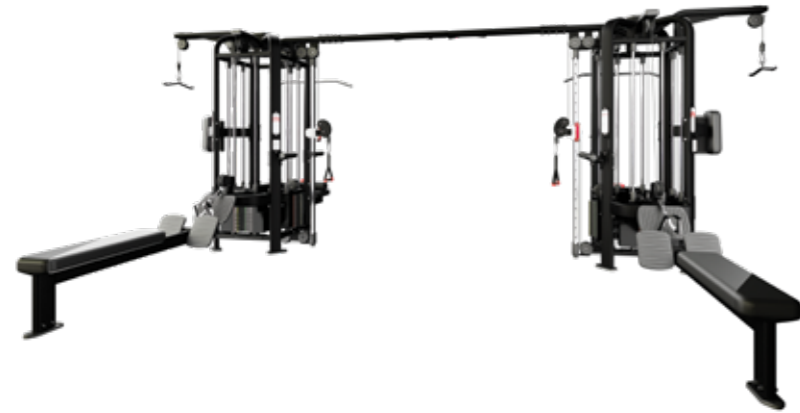

9 Station
9NP-M9619

WIDTH	240 in (609 cm)
LENGTH	152 in (387 cm)
HEIGHT	94 in (239 cm)
STACK WEIGHT	Lat Pull Down/Low Row 297 lb (135 kg) Triceps Press 231 lb (105 kg) Cross over 2 x 115.5 lb (2 x 52.5 kg)
PRODUCT WEIGHT	3690 lb (1673 kg)



Mid-Row
731-9475

WIDTH	30 in (76 cm)
LENGTH	142 in (361cm)
HEIGHT	94 in (239 cm)
STACK WEIGHT	297 lbs (135 kg)
PRODUCT WEIGHT	162 lbs (90 kg)
TOTAL STACK WEIGHT	297 lbs (135 kg)



HIIT Rope Mount
731-9678

WEIGHT	34 lbs (15.5 kg)
---------------	------------------

For HIIT ROPE Specs see page 33



14 Station
9NP-M9620

WIDTH	395 in (1003 cm)
LENGTH	152 in (387 cm)
HEIGHT	94 in (239 cm)
STACK WEIGHT	Lat Pull Down/Low Row 297 lb (135 kg) Triceps Press 231 lb (105 kg) Cross over 2 x 115.5 lb (2 x 52.5 kg)
PRODUCT WEIGHT	5565 lb (2524 kg)

STRENGTH

Nautilus

Benches

Every detail matters when it comes to durability, functionality, and aesthetics. Nautilus Benches are engineered to exceed industry standards, offering a premium strength-training experience that seamlessly integrates with our full strength lineup. From Olympic benches with optional weight storage to our innovative abdominal and back extension benches, each piece is designed for stability, comfort, and longevity in high-use environments. With a consistent design language across all Nautilus strength equipment, your free weight area will have a cohesive, professional look—ensuring both performance and visual impact for your facility.

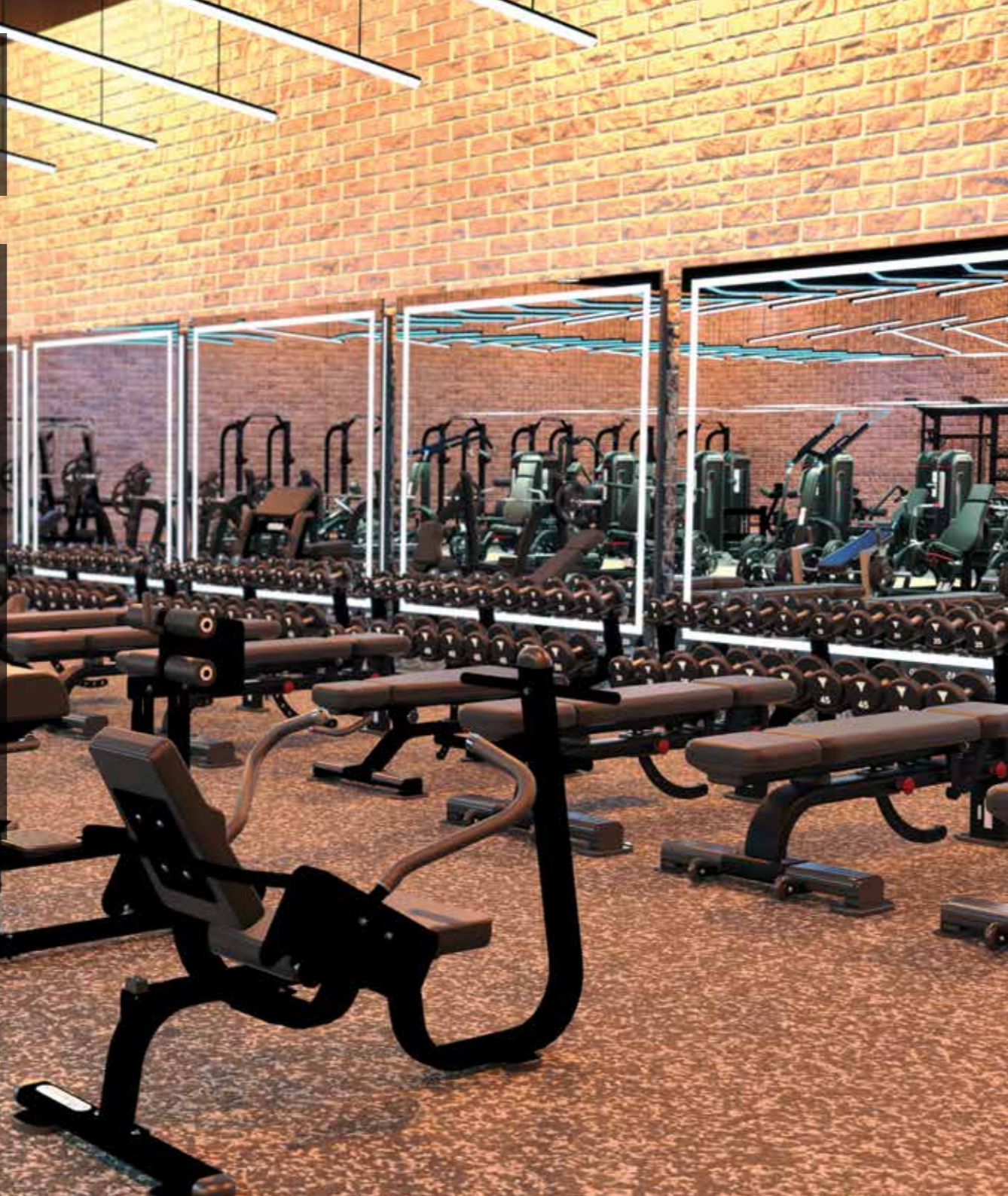

Multi-Adjustable Bench
9NP-B7506

WIDTH	27 in (69 cm)
LENGTH	55 in (140 cm)
HEIGHT	16.5 in (42 cm)
PRODUCT WEIGHT	117 lb (53 kg)



Flat Bench
9NP-B7507

WIDTH	27 in (69 cm)
LENGTH	55 in (140 cm)
HEIGHT	20 in (51 cm)
PRODUCT WEIGHT	77 lb (35 kg)



Adjustable Decline Bench
9NP-B7508

WIDTH	34 in (86 cm)
LENGTH	53 in (135 cm)
HEIGHT	31 in (79 cm)
PRODUCT WEIGHT	155 lb (70 kg)



Adjustable Abdominal Bench
9NP-B7510

WIDTH	35 in (89 cm)
LENGTH	55 in (140 cm)
HEIGHT	45 in (114 cm)
PRODUCT WEIGHT	159 lb (72 kg)



Utility Bench
9NP-B7516

WIDTH	27 in (69 cm)
LENGTH	34 in (86 cm)
HEIGHT	38 in (97 cm)
PRODUCT WEIGHT	71 lb (32 kg)



Stool
9NP-B7521

WIDTH	31 in (79 cm)
LENGTH	27 in (68 cm)
HEIGHT	17 in (44 cm)
PRODUCT WEIGHT	27 lb (12 kg)



Adjustable Back Extension
9NP-B7514

WIDTH	34 in (86 cm)
LENGTH	53 in (135 cm)
HEIGHT	31 in (79 cm)
PRODUCT WEIGHT	157 lb (71 kg)



Glute Ham
9NP-B7522

WIDTH	43 in (110 cm)
LENGTH	72 in (182 cm)
HEIGHT	48 in (122 cm)
PRODUCT WEIGHT	188 lb (85 kg)

STRENGTH

Nautilus - Benches



Preacher Curl
9NP-B7509

WIDTH	30 in (76 cm)
LENGTH	43 in (109 cm)
HEIGHT	40 in (102 cm)
PRODUCT WEIGHT	163 lb (74 kg)



Standing Preacher Curl
9NP-B7515

WIDTH	30 in (76 cm)
LENGTH	39 in (99 cm)
HEIGHT	45 in (114 cm)
PRODUCT WEIGHT	174 lb (79 kg)



Olympic Military Press
9NP-B7205

WIDTH	74 in (188 cm)
LENGTH	65 in (165 cm)
HEIGHT	60 in (152 cm)
PRODUCT WEIGHT	269 lb (122 kg)



Stretch Bench
9NP-B7524

WIDTH	28 in (71 cm)
LENGTH	52 in (132 cm)
HEIGHT	36 in (91 cm)
PRODUCT WEIGHT	60 lb (27 kg)



Leg Raise/Dip
9NP-B7517

WIDTH	28 in (71 cm)
LENGTH	61 in (155 cm)
HEIGHT	66 in (168 cm)
PRODUCT WEIGHT	267 lb (121 kg)



Pull-Up/Dip/Leg Raise
9NP-B7511

WIDTH	48 in (122 cm)
LENGTH	61 in (155 cm)
HEIGHT	90 in (229 cm)
PRODUCT WEIGHT	335 lb (152 kg)



Olympic Bench Press
9NP-B7202

WIDTH	65 in (165 cm)
LENGTH	73 in (185 cm)
HEIGHT	49 in (124 cm)
PRODUCT WEIGHT	115 lb (52 kg)



Decline Bench Press
9NP-B7204

WIDTH	50 in (127 cm)
LENGTH	70 in (178 cm)
HEIGHT	49 in (124 cm)
PRODUCT WEIGHT	177 lb (80 kg)



Incline Bench Press
9NP-B7203

WIDTH	51 in (130 cm)
LENGTH	59 in (150 cm)
HEIGHT	59 in (150 cm)
PRODUCT WEIGHT	185 lb (84 kg)

A PERFECT PARTNERSHIP



Throwdown Free Weights pair perfectly with our strength products allowing you to get everything in one place. You can even find free weight sets crafted specifically for popular Benches & Racks, Nautilus Leverage and Plate Loaded products.

STRENGTH

Nautilus

Racks

Strength training demands durability, versatility, and innovation—Nautilus Racks deliver all three. Designed to seamlessly integrate with our strength lines, they provide the right solution for your members' needs, with the option to include plate storage for added efficiency.

At the core of our system is the SVA Platform—the industry's most advanced platform technology, engineered to reduce noise, vibration, and shock for a superior lifting experience. Built to exceed industry standards in strength and durability, Nautilus Racks offer the ultimate combination of safety, performance, and aesthetics, ensuring your free weight area is as functional as it is visually cohesive.



SINGLE Dumbbell Rack
NP-R8009

WIDTH	90 in (229 cm)
LENGTH	28 in (71 cm)
HEIGHT	26 in (66 cm)
PRODUCT WEIGHT	155 lb (70 kg)



Double Dumbbell Rack
NP-R8022

WIDTH	90 in (229 cm)
LENGTH	38 in (97 cm)
HEIGHT	26 in (66 cm)
PRODUCT WEIGHT	255 lb (116 kg)



Triple Dumbbell Rack
NP-R8023

WIDTH	90 in (229 cm)
LENGTH	38 in (97 cm)
HEIGHT	39 in (99 cm)
PRODUCT WEIGHT	387 lb (176 kg)



Beauty Bell Rack
NP-R8014

WIDTH	32 in (81 cm)
LENGTH	40 in (102 cm)
HEIGHT	40 in (102 cm)
PRODUCT WEIGHT	132 lb (60 kg)



2-Sided Olympic Weight Tree
NP-R7512

WIDTH	27 in (69 cm)
LENGTH	35 in (89 cm)
HEIGHT	40 in (102 cm)
PRODUCT WEIGHT	86 lb (39 kg)



4-Sided Olympic Weight Tree
NP-R7513

WIDTH	28 in (71 cm)
LENGTH	28 in (71 cm)
HEIGHT	46 in (117 cm)
PRODUCT WEIGHT	135 lb (61 kg)



Barbell Rack
NP-R8012

WIDTH	36 in (91 cm)
LENGTH	38 in (97 cm)
HEIGHT	53 in (135 cm)
PRODUCT WEIGHT	159 lb (72 kg)



Accessory Rack
NP-R8013

WIDTH	28 in (71 cm)
LENGTH	35 in (89 cm)
HEIGHT	51 in (130 cm)
PRODUCT WEIGHT	141 lb (64 kg)

STRENGTH

Nautilus - Racks & Platforms



4' SVA Bamboo Platform II
9-HDP4D-BB2

WIDTH	95 in (241 cm)
LENGTH	115 in (292 cm)
HEIGHT	4 in (10 cm)
PRODUCT WEIGHT	943 lb (428 kg)



**Platform shown with Half Rack HDHR2*



**Platform shown with Half Rack HDHR2*

6' SVA Bamboo Platform II
9-HDP6D-BB2

WIDTH	95 in (241 cm)
LENGTH	141 in (358 cm)
HEIGHT	4 in (10 cm)
PRODUCT WEIGHT	943 lb (428 kg)



**Platform shown with Half Rack HDHR2*

6' Bamboo Platform II
9-HDP6-BB2

WIDTH	95 in (241 cm)
LENGTH	141 in (358 cm)
HEIGHT	3 in (8 cm)
PRODUCT WEIGHT	751 lb (341 kg)



**Platform shown with Half Rack HDHR2*

4' Bamboo Platform II
HDP4-BB2

WIDTH	95 in (241 cm)
LENGTH	115 in (292 cm)
HEIGHT	3 in (8 cm)
PRODUCT WEIGHT	655 lb (297 kg)



4' SVA Bamboo Stand Alone
Platform 9-HDP4D-BB2-SA

WIDTH	95 in (241 cm)
LENGTH	53 in (135 cm)
HEIGHT	4 in (10 cm)
PRODUCT WEIGHT	408 lb (185 kg)



6' SVA Bamboo Stand Alone
Platform II 9-HDP6D-BB2-SA

WIDTH	95 in (241 cm)
LENGTH	141 in (358 cm)
HEIGHT	4 in (10 cm)
PRODUCT WEIGHT	943 lb (428 kg)



Half Rack
HDHR2

WIDTH	72 in (183 cm)
LENGTH	63 in (160 cm)
HEIGHT	97 in (246 cm)
PRODUCT WEIGHT	512 lb (232 kg)



Squat Rack
HD-R8008

WIDTH	80 in (203 cm)
LENGTH	71 in (180 cm)
HEIGHT	79 in (201 cm)
PRODUCT WEIGHT	445 lb (202 kg)



Power Cage
HD-R8006

WIDTH	63 in (160 cm)
LENGTH	69 in (174 cm)
HEIGHT	94 in (239 cm)
PRODUCT WEIGHT	538 lb (244 kg)



Power Cage SVA Combo

9HD-R8006, 9-HDP6D-BB2, 731-9082-KT, 731-9092-KT

WIDTH	95 in (241 cm)
LENGTH	143 in (363 cm)
HEIGHT	89 in (226 cm)
PRODUCT WEIGHT	1276 lb (579 kg)

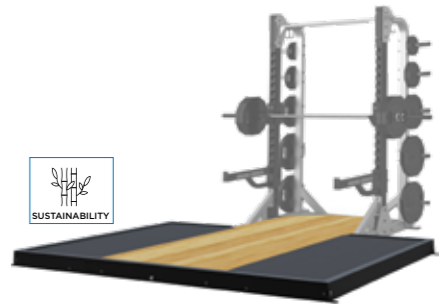

6' HD SVA Platform, LF Half Rack
9-HDP6D-LFHR

WIDTH	95 in (241 cm)
LENGTH	115 in (292 cm)
HEIGHT	4 in (10 cm)
PRODUCT WEIGHT	751 lb (341 kg)

**Platform shown with Life Fitness HD Elite Half Rack*

STRENGTH

Instinct

Instinct Strength Solutions

Experience the ideal fusion of functionality and durability with instinct Light Commercial Strength Solutions. Our sleek and intuitive designs are crafted to elevate your fitness space, seamlessly meeting the expectations of residents, guests, and employees alike. Specifically engineered to fit within light commercial footprints, our solutions encompass functional training, freeweight, and selectorized fitness pieces. Tailored to accommodate all users' needs, our offerings maximize convenience and efficiency throughout your facility, ensuring an exceptional experience for everyone.

Complementing our strength solutions are the cutting-edge cardio offerings from our Star Trac and StairMaster brands, providing a comprehensive fitness experience that exceeds expectations. Together, we deliver everything you need to create a standout fitness amenity.



Chest Press 9NL-S2100

WIDTH	28 in (71 cm)
LENGTH	49 IN (124 CM)
HEIGHT	55 in (140 cm)
STACK WEIGHT	235 lb (107 kg)
PRODUCT WEIGHT	427 lb (194 kg)



Shoulder Press
9NL-S4100

WIDTH	53 in (135 cm)
LENGTH	58 in (147 cm)
HEIGHT	55 in (140 cm)
STACK WEIGHT	190 lb (86 kg)
PRODUCT WEIGHT	448 lb (203 kg)



Dual Multi-Press
9NL-D2120

WIDTH	55 in (140 cm)
LENGTH	74 IN (188 CM)
HEIGHT	55 in (140 cm)
STACK WEIGHT	235 lb (107 kg)
PRODUCT WEIGHT	506 lb (230 kg)



Dual Pectoral Fly/
Rear Deltoid
9NL-D2110

WIDTH	50 in (127 cm)
LENGTH	54 in (137 cm)
HEIGHT	79 in (201 cm)
STACK WEIGHT	190 lb (86 kg)
PRODUCT WEIGHT	426 lb (193 kg)



Dual Lat Pull Down/
Vertical Row
9NL-D3340

WIDTH	47 in (119 cm)
LENGTH	50 in (127 cm)
HEIGHT	84 in (213 cm)
STACK WEIGHT	235 lb (107kg)
PRODUCT WEIGHT	473 lb (215 kg)



Lat Pull Down
9NL-S3310

WIDTH	47 in (119 cm)
LENGTH	60 in (152 cm)
HEIGHT	73 in (185 cm)
STACK WEIGHT	235 lb (107kg)
PRODUCT WEIGHT	515 lb (234 kg)

STRENGTH

Nautilus - Instinct



Dual Adjustable Pulley
9NL-D2002

WIDTH	36 in (91 cm)
LENGTH	66 in (168 cm)
HEIGHT	81 in (207 cm)
STACK WEIGHT	2 X 400 lb (2 X 181 kg) 2 X 100 lb (AT HANDLE)
PRODUCT WEIGHT	894 lb (406 kg)



Vertical Row
9NL-S3320

WIDTH	46 in (117 cm)
LENGTH	48 in (122 cm)
HEIGHT	55 in (140 cm)
STACK WEIGHT	235 lb (107 kg)
PRODUCT WEIGHT	405 lb (183 kg)



Dual Biceps Curl/
Triceps Extension
9NL-D5120

WIDTH	39 in (99 cm)
LENGTH	52 in (132 cm)
HEIGHT	55 in (140 cm)
STACK WEIGHT	190 lb (86 kg)
PRODUCT WEIGHT	395 lb (180 kg)



Dual Leg Press/Calf Raise 9NL-D1013

WIDTH	39 in (99 cm)
LENGTH	74 in (188 cm)
HEIGHT	55 in (140 cm)
STACK WEIGHT	235 lb (107 kg)
PRODUCT WEIGHT	612 lb (278 kg)



Dual Leg Extension/Leg Curl
9NL-D1014

WIDTH	37 in (94 cm)
LENGTH	56 in (142 cm)
HEIGHT	55 in (140 cm)
STACK WEIGHT	190 lb (86 kg)
PRODUCT WEIGHT	484 lb (220 kg)



Leg Extension 9NL-S1010

WIDTH	37 in (94 cm)
LENGTH	41 in (104 cm)
HEIGHT	55 in (140 cm)
STACK WEIGHT	190 lb (86 kg)
PRODUCT WEIGHT	436 lb (198 kg)



Leg Curl 9NL-S1011

WIDTH	37 in (94 cm)
LENGTH	56 in (140 cm)
HEIGHT	55 in (140 cm)
STACK WEIGHT	190 lb (86 kg)
PRODUCT WEIGHT	469 lb (213 kg)



Dual inner/Outer Thigh 9NL-D1015

WIDTH	27 in (69 cm)
LENGTH	57 in (145 cm)
HEIGHT	55 in (140 cm)
STACK WEIGHT	150 lb (68 kg)
PRODUCT WEIGHT	451 lb (205 kg)



Glute Press 9NL-S1012

WIDTH	37 in (94 cm)
LENGTH	67 in (170 cm)
HEIGHT	55 in (140 cm)
STACK WEIGHT	120 lb (55 kg)
PRODUCT WEIGHT	313 lb (142 kg)



Rotary Torso
9NL-S6300

WIDTH	38 in (97 cm)
LENGTH	39 in (99 cm)
HEIGHT	55 in (140 cm)
STACK WEIGHT	190 lb (86 kg)
PRODUCT WEIGHT	418 lb (190 kg)



Dual Abdominal/Lower Back
9NL-D6330

WIDTH	40 in (102 cm)
LENGTH	45 in (114 cm)
HEIGHT	55 in (140 cm)
STACK WEIGHT	120 lb (54 kg)
PRODUCT WEIGHT	369 lb (168 kg)

STRENGTH

Nautilus - Instinct



Multi-Adjustable Bench 100
9NN-B7506

WIDTH	25 in (64 cm)
LENGTH	61 in (155 cm)
HEIGHT	17 in (44 cm)
PRODUCT WEIGHT	80 lb (36 kg)



Multi-Adjustable Bench
9NN-B7501

WIDTH	27 in (69 cm)
LENGTH	53 in (135 cm)
HEIGHT	18 in (46 cm)
PRODUCT WEIGHT	73 lb (33 kg)



Adjustable Abdominal
Decline Bench
9NN-B7200

WIDTH	25 in (64 cm)
LENGTH	53 in (135 cm)
HEIGHT	34 in (86 cm)
PRODUCT WEIGHT	95 lb (43 kg)



Ab Bench
9NN-B7505

WIDTH	37 in (94 cm)
LENGTH	61 in (155 cm)
HEIGHT	42 in (106 cm)
PRODUCT WEIGHT	148 lb (67 kg)



45 Degree Back Extension
9NN-B7502

WIDTH	32 in (81 cm)
LENGTH	54 in (137 cm)
HEIGHT	39 in (99 cm)
PRODUCT WEIGHT	97 lb (44 kg)



Olympic Flat Bench
9NN-B7503

WIDTH	61 in (155 cm)
LENGTH	63 in (160 cm)
HEIGHT	54 in (137 cm)
PRODUCT WEIGHT	185 lb (84 kg)



Olympic Incline Bench
9NN-B7201

WIDTH	61 in (155 cm)
LENGTH	63 in (160 cm)
HEIGHT	69 in (175 cm)
PRODUCT WEIGHT	269 lb (122 kg)



Dumbbell Rack 10-Pair/2 Tier
9NN-R8001

WIDTH	105 in (267 cm)
LENGTH	29 in (74 cm)
HEIGHT	37 in (94 cm)
PRODUCT WEIGHT	221 lb (100 kg)



Dumbbell Rack 10-Pair/3 Tier
9NN-R8002

WIDTH	69 in (175 cm)
LENGTH	29 in (74 cm)
HEIGHT	50 in (127 cm)
PRODUCT WEIGHT	243 lb (110 kg)

STRENGTH

Light Commercial Strength



Half Rack
9NN-R8303-60AAS

WIDTH	87 in (221cm)
LENGTH	54.7 in (139.7 cm)
HEIGHT	90 in (228.6 cm)
PRODUCT WEIGHT	370.5lb (168kg)



Smith Machine
9NN-L8506-60AAS

WIDTH	52.36 in (133 cm)
LENGTH	88 in (223.5 cm)
HEIGHT	88 in (223.5 cm)
PRODUCT WEIGHT	445.5lb (202kg)



8' Alpha XTC 73-00318

WIDTH	95 in (231.4cm)
LENGTH	56 in (142.3cm)
HEIGHT	48.5 in (123.1cm)



8' Add-On 73-00319

WIDTH	105 in (267 cm)
LENGTH	45 in (118 cm)
HEIGHT	46 in (116 cm)



3 Stack Multi-Station
9NN-M8008-60AAS

WIDTH	108 in (275cm)
LENGTH	136 in (346cm)
HEIGHT	86 in (218cm)
WEIGHT-STACK	200 lb (91kg)
PRODUCT WEIGHT	1605 lb (728 kg)



Accessory Rack
9NN-R8015-60AAS

WIDTH	70 in (178 cm)
LENGTH	30 in (76.2 cm)
HEIGHT	90 in (228.6 cm)
PRODUCT WEIGHT	152 lb (48.94 kg)



3-Tier Dumbbell Rack
9NN-R8003-60AAS

WIDTH	36.5 in (93 cm)
LENGTH	64.5 in (164 cm)
HEIGHT	40 in (101.6 cm)
PRODUCT WEIGHT	198.5 lb (90 kg)



Vertical Dumbbell Rack
9NN-R8016-60AAS

WIDTH	30.5 in (77.5 cm)
LENGTH	24 in (61 cm)
HEIGHT	62 in (157.5 cm)
PRODUCT WEIGHT	103 lb (46.72 kg)

PILATES

Pilates by Nautilus brings together two disciplines united by one mission: building bodies that are strong, balanced, and built to last. Through spring-based resistance and controlled, full-range movement, Pilates targets deep stabilizing muscles, improves joint integrity, and builds the functional foundation that keeps members training harder, recovering faster, and coming back longer. The Reformer, Wall Board, and Chair deliver controlled, multi-plane movement that develops the mobility, stability, and core control that makes every lift stronger and every body more resilient—trusted Nautilus performance, extended across the full continuum of strength.

Pilates
by NAUTILUS



PILATES

Nautilus



Nautilus Pilates Reformer extends strength training through the body's full range of motion, building control, stability, and resilience. By strengthening stabilizers and improving alignment, it helps members stay in a ready state—moving better, performing stronger, and reducing injury risk. Pilates becomes the essential complement that sustains long-term strength and confidence.

Nautilus Pilates Reformer
9-4790-MUNBP0

DIMENSIONS	103 in x 34.5 in (2616 mm x 874 mm)
PRODUCT WEIGHT	207 lb (94 kg)
FRAME MATERIAL AND FINISH	Maple Wood/ Water sealed
UPHOLSTERY COLOR	Smooth black, comfortable upholstery with waterfall padding that's easy to clean & maintain
RESISTANCE SYSTEM	5 fully dipped spring hooks to prevent premature spring wear while allowing for up to 46 configurable resistance levels
LOCKING SYSTEM	5 adjustable spring load self locking system
MAX USER WEIGHT	350 lb (159 kg)



Nautilus Pilates Wall Board delivers reformer-inspired strength through controlled, upright movement that builds postural strength, core control, and joint-friendly resilience. Using adjustable spring resistance and bodyweight support, it enables full-body Pilates training in minimal space while expanding programming options in both dedicated Pilates corners and full studios.

Nautilus Pilates Wall Board
9-4780-MUNBP0

DIMENSIONS	79 in x 26.5 in x 3 in (2000 mm x 675 mm x 80 mm)
PRODUCT WEIGHT	35 lb (16 kg)
FRAME MATERIAL AND FINISH	Maple Wood/ Water sealed
UPHOLSTERY COLOR	N/A
RESISTANCE SYSTEM	4 fully dipped spring hooks to prevent premature spring wear
LOCKING SYSTEM	Spring with integrated snap hook
MAX USER WEIGHT	350 lb (159 kg)



* Not Sold in the United States

Nautilus Pilates Chair delivers compact, full-body strength through controlled, vertical movement that builds balance, stability, and joint-friendly power. Using spring resistance and bodyweight loading, it supports seated and standing Pilates work that enhances coordination, mobility, and injury-resistant strength. Ideal for studios seeking versatile programming without sacrificing space or performance.

Nautilus Pilates Excercise Chair*
9-4770-MUNBP0

DIMENSIONS	30 in x 23.5 in (765 mm x 596 mm)
PRODUCT WEIGHT	44 lb (20 kg)
FRAME MATERIAL AND FINISH	Maple Wood/ Water sealed
UPHOLSTERY COLOR	Smooth black, comfortable upholstery with waterfall padding that's easy to clean & maintain
RESISTANCE SYSTEM	2 fully dipped spring hooks to prevent premature spring wear
LOCKING SYSTEM	4 adjustable vertical half moon locking system
MAX USER WEIGHT	350 lb (159 kg)

STRENGTH

Throwdown - Freeweights



URETHANE DUMBBELLS

- Solid steel core, one piece construction
- Premium urethane that will not discolor
- Wear resistant matte textured surfaces
- Industrial hard chrome handle finish
- Medium knurl
- Handles 5-45 = 31mm
- Handles 47.5-200 = 34mm

Sets

URETHANE DUMBBELL - SETS lb

5 - 25 lb Set	WT	5 lb	10 lb	15 lb	20 lb	25 lb
9-UDC4-SMLB-THD-60	QTY	1 pair	1 pair	1 pair	1 pair	1 pair
30 - 50 lb Set	WT	30 lb	35 lb	40 lb	45 lb	50 lb
9-UDC4-MDLB-THD-60	QTY	1 pair	1 pair	1 pair	1 pair	1 pair
55 - 75 lb Set	WT	55 lb	60 lb	65 lb	70 lb	75 lb
9-UDC4-LGLB-THD-60	QTY	1 pair	1 pair	1 pair	1 pair	1 pair
80 - 100 lb Set	WT	80 lb	85 lb	90 lb	95 lb	100 lb
9-UDC4-XLLB-THD-60	QTY	1 pair	1 pair	1 pair	1 pair	1 pair
7.5 - 27.5 lb Set	WT	7.5 lb	12.5 lb	17.5 lb	22.5 lb	27.5 lb
9-UDC4-S2LB-THD-60	QTY	1 pair	1 pair	1 pair	1 pair	1 pair
32.5 - 52.5 lb Set	WT	32.5 lb	37.5 lb	42.5 lb	47.5 lb	52.5 lb
9-UDC4-M2LB-THD-60	QTY	1 pair	1 pair	1 pair	1 pair	1 pair
5 - 100 lb Club Set (4 Sets)				9-UDC4-CLUBLB-THD-60		

URETHANE DUMBBELL - SETS kg

2.5 - 12.5 kg Set	WT	2.5 kg	5 kg	7.5 kg	10 kg	12.5 kg
9-UDC4-SMKG-THD-60	QTY	1 pair	1 pair	1 pair	1 pair	1 pair
15 - 25 kg Set	WT	15 kg	17.5 kg	20 kg	22.4 kg	25 kg
9-UDC4-MDKG-THD-60	QTY	1 pair	1 pair	1 pair	1 pair	1 pair
27.5 - 37.5 Set	WT	27.5 kg	30 kg	32.5 kg	35 kg	37.5 kg
9-UDC4-LGKG-THD-60	QTY	1 pair	1 pair	1 pair	1 pair	1 pair
40 - 50 kg Set	WT	40 kg	42.5 kg	45 kg	47.5	50 kg
9-UDC4-XLKG-THD-60	QTY	1 pair	1 pair	1 pair	1 pair	1 pair
1 - 5 kg Set	WT	1 kg	2 kg	3 kg	4 kg	5 kg
9-UDC4-S2KG-THD-60	QTY	1 pair	1 pair	1 pair	1 pair	1 pair
6 - 10 kg Set	WT	6 kg	7 kg	8 kg	9 kg	10 kg
9-UDC4-M2KG-THD-60	QTY	1 pair	1 pair	1 pair	1 pair	1 pair
2.5 - 50kg Club Set (4 Sets)				9-UDC4-CLUBKG-THD-60		

Individual Dumbbells

URETHANE DUMBBELLS - SINGLE lb

UDC4-105LB-THD-60	WT	105 lb	UDC4-155LB-THD-60	WT	155 lb
UDC4-110LB-THD-60	WT	110 lb	UDC4-160LB-THD-60	WT	160 lb
UDC4-115LB-THD-60	WT	115 lb	UDC4-165LB-THD-60	WT	165 lb
UDC4-120LB-THD-60	WT	120 lb	UDC4-170LB-THD-60	WT	170 lb
UDC4-125LB-THD-60	WT	125 lb	UDC4-175LB-THD-60	WT	175 lb
UDC4-130LB-THD-60	WT	130 lb	UDC4-180LB-THD-60	WT	180 lb
UDC4-135LB-THD-60	WT	135 lb	UDC4-185LB-THD-60	WT	185 lb
UDC4-140LB-THD-60	WT	140 lb	UDC4-190LB-THD-60	WT	190 lb
UDC4-145LB-THD-60	WT	145 lb	UDC4-195LB-THD-60	WT	195 lb
UDC4-150LB-THD-60	WT	150 lb	UDC4-200LB-THD-60	WT	200 lb

URETHANE DUMBBELLS - SINGLE kg

UDC4-52.5KG-THD-60	WT	52.5 kg
UDC4-55KG-THD-60	WT	55 kg
UDC4-57.5KG-THD-60	WT	57.5 kg
UDC4-60KG-THD-60	WT	60 kg
UDC4-62.5KG-THD-60	WT	62.5 kg
UDC4-65KG-THD-60	WT	65 kg
UDC4-67.5KG-THD-60	WT	67.5 kg
UDC4-70KG-THD-60	WT	70 kg
UDC4-72.5KG-THD-60	WT	72.5 kg
UDC4-75KG-THD-60	WT	75 kg

STRENGTH

Throwdown - Freeweights

URETHANE OLYMPIC PLATES

- Three comfortable grips
- Thick premium urethane covering
- Heavy, long lasting texture
- Fits snug on bar

URETHANE BUMPER PLATES

- Encased in premium urethane
- One piece internal steel hub
- 90 on "A" shore durometer
- Dead bounce
- Bright, vibrant colors
- Bumper discs have 17.7" (450mm) outer diameter (IWF standards)

BEAUTY BELLS

- Solid steel construction
- Industrial hard chromed
- Matte finish
- Medium diamond knurl pattern
- Embossed weight indications

RUBBER BUMPER PLATES

- High Quality Rubber
- Hard Chrome Steel Hub
- 88-93A Shore Diameter
- Dead Bounce
- Bright Vibrant Colors
- Bumper Plates have 17.7" (450mm) outer diameter

Single Plates

URETHANE OLYMPIC PLATES - SINGLE

UPR4-2.5LB-60THD	WT	2.5 lb
UPR4-05LB-60THD	WT	5 lb
UPR4-10LB-60THD	WT	10 lb
UPR4-25LB-60THD	WT	25 lb
UPR4-35LB-60THD	WT	35 lb
UPR4-45LB-60THD	WT	45 lb

URETHANE BUMPER PLATES - SINGLE

UBP4-10LB-THD-BLK	WT	10 lb
UBP4-25LB-THD-GRN	WT	25 lb
UBP4-35LB-THD-YLW	WT	35 lb
UBP4-45LB-THD-BLU	WT	45 lb
UBP4-55LB-THD-RED	WT	55 lb

RUBBER BUMPER PLATES - SINGLE

RBP4-10LB-THD-BLK	WT	10 lb
RBP4-25LB-THD-GRN	WT	25 lb
RBP4-35LB-THD-YLW	WT	35 lb
RBP4-45LB-THD-BLU	WT	45 lb
RBP4-55LB-THD-RED	WT	55 lb

Beauty Bell Sets

BEAUTY BELL SET

Beauty Bell Set	WT	5 lb	8 lb	10 lb	12 lb	15 lb
9-CDFLB	QTY	3 pair	3 pair	2 pair	2 pair	2 pair

URETHANE OLYMPIC PLATES - SINGLE

UPR4-1.25KG-THD-60	WT	1.25 kg
UPR4-2.5KG-THD-60	WT	2.5 kg
UPR4-05KG-THD-60	WT	5 kg
UPR4-10KG-THD-60	WT	10 kg
UPR4-15KG-THD-60	WT	15 kg
UPR4-20KG-THD-60	WT	20 kg
UPR4-25KG-THD-60	WT	25 kg

URETHANE BUMPER PLATES - SINGLE

UBP4-05KG-THD-BLK	WT	5 kg
UBP4-10KG-THD-GRN	WT	10 kg
UBP4-15KG-THD-YLW	WT	15 kg
UBP4-20KG-THD-BLU	WT	20 kg
UBP4-25KG-THD-RED	WT	25 kg

RUBBER BUMPER PLATES - SINGLE

RBP4-05KG-THD-BLK	WT	5 kg
RBP4-10KG-THD-GRN	WT	10 kg
RBP4-15KG-THD-YLW	WT	15 kg
RBP4-20KG-THD-BLU	WT	20 kg
RBP4-25KG-THD-RED	WT	25 kg

BEAUTY BELL SET

Beauty Bell Set	WT	1 kg	2 kg	3 kg	4 kg	5 kg	6 kg	7 kg	8 kg	9 kg	10 kg
9-CDFKG	QTY	1 pair	1 pair	1 pair	1 pair	1 pair	1 pair	1 pair	1 pair	2 pair	2 pair

STRENGTH

Throwdown - Barbells



STRAIGHT BARBELLS

- Solid steel, one piece construction
- Thick premium urethane covering
- Wear resistant matte textured surfaces
- Industrial hard chromed
- Handle Diameter - 32 mm

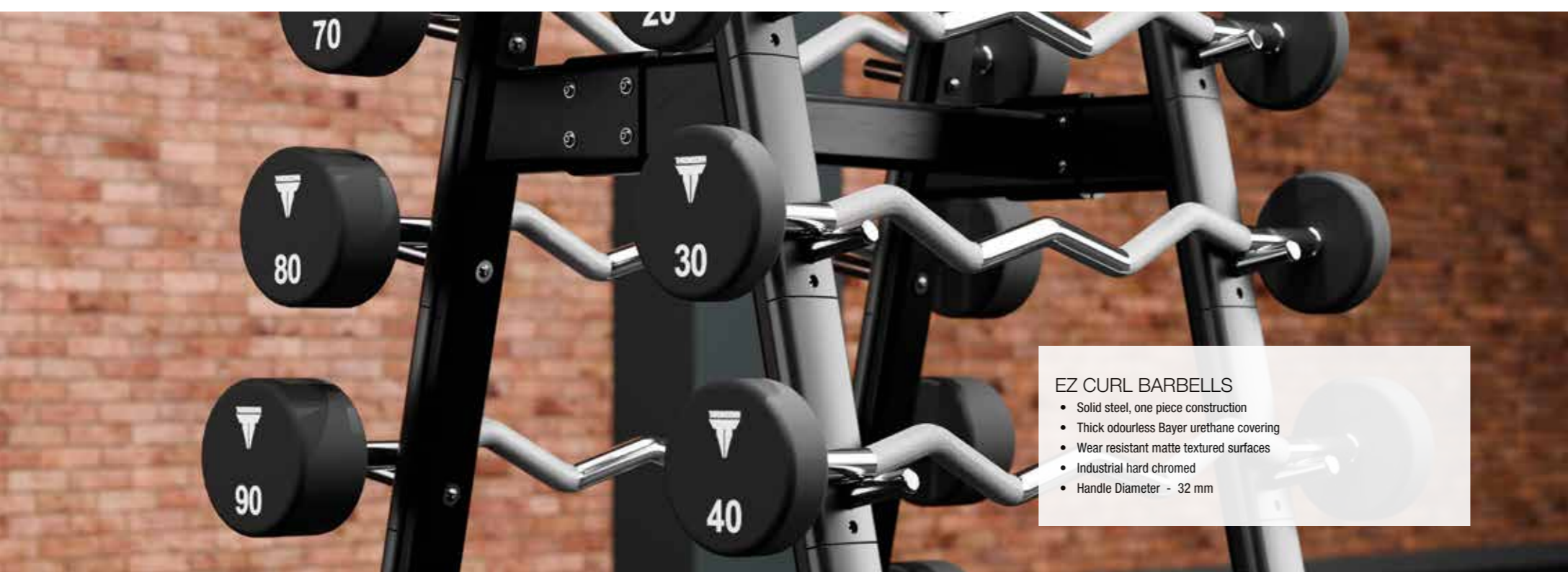

EZ CURL BARBELLS

- Solid steel, one piece construction
- Thick odourless Bayer urethane covering
- Wear resistant matte textured surfaces
- Industrial hard chromed
- Handle Diameter - 32 mm

Sets

STRAIGHT BARBELL SET

Straight Barbell Set	WT	20 lb	30 lb	40 lb	50 lb	60 lb	70 lb	80 lb	90 lb	100 lb	110 lb
9-UBS4-CLUBLB-60THD	QTY	1 each	1 each	1 each	1 each	1 each	1 each	1 each	1 each	1 each	1 each

STRAIGHT BARBELL SET

Straight Barbell Set	WT	10 kg	12.5 kg	15 kg	17.5 kg	20 kg	25 kg	30 kg	35 kg	40 kg	45 kg
9-UBS4-CLUBKG-60THD	QTY	1 each	1 each	1 each	1 each	1 each	1 each	1 each	1 each	1 each	1 each

EZ CURL BARBELL SET

EZ Curl Barbell Set	WT	20 lb	30 lb	40 lb	50 lb	60 lb	70 lb	80 lb	90 lb	100 lb	110 lb
9-UBC-CLUBIB-60THD	QTY	1 each	1 each	1 each	1 each	1 each	1 each	1 each	1 each	1 each	1 each

EZ CURL BARBELL SET

EZ Curl Barbell Set	WT	10 kg	12.5 kg	15 kg	17.5 kg	20 kg	25 kg	30 kg	35 kg	40 kg	45 kg
9-UBC4-CLUBKG-60THD	QTY	1 each	1 each	1 each	1 each	1 each	1 each	1 each	1 each	1 each	1 each

CUSTOMIZATION

Brand is everything. And now, you can make an even longer lasting impression with customized free weights. With custom colored urethane and up to 2-color logos on weights, plates, dumbbells and barbells you can enhance your brand. Put your best foot forward with Throwdown custom free weights.

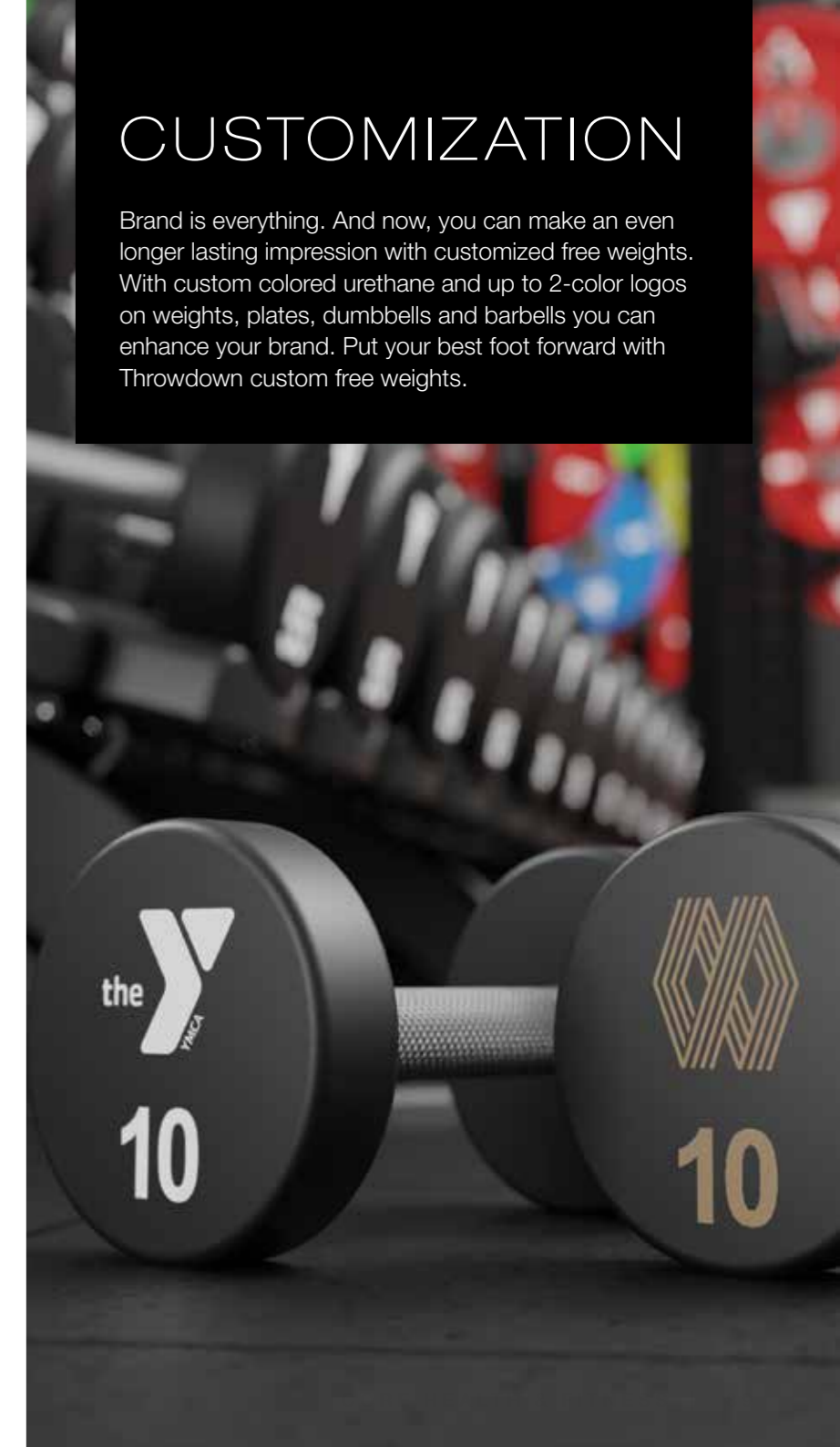

STRENGTH

Throwdown Bars

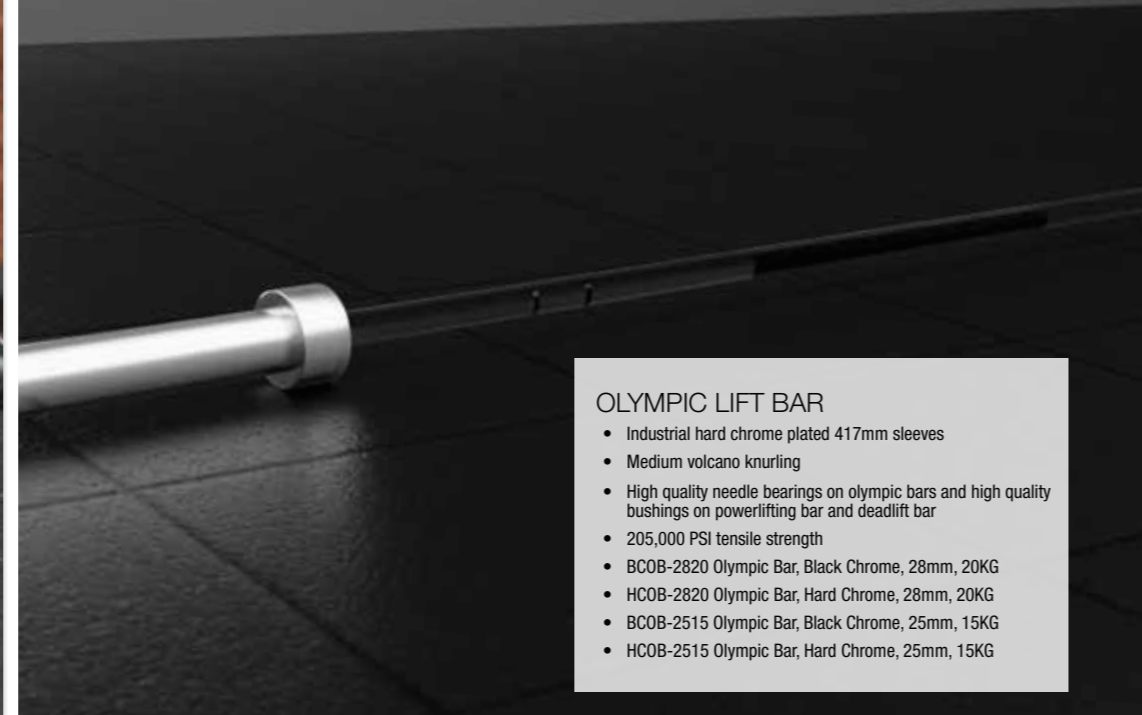
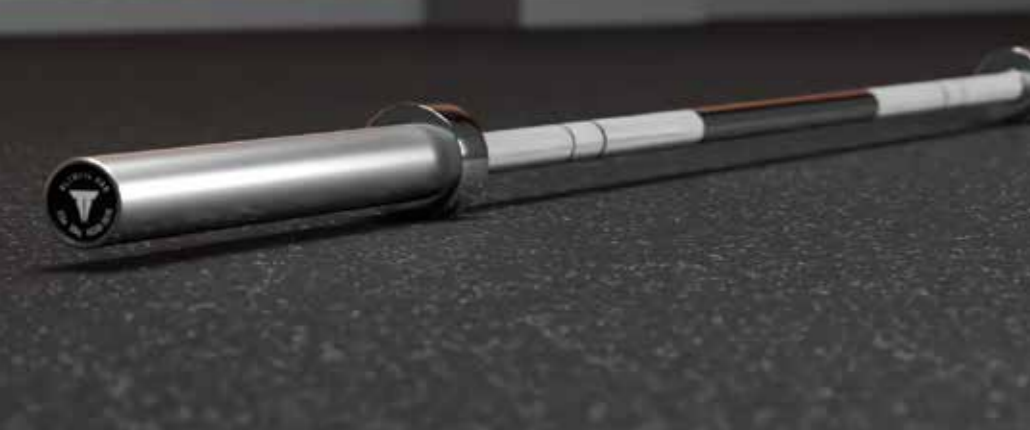

OLYMPIC LIFT BAR

- Industrial hard chrome plated 417mm sleeves
- Medium volcano knurling
- High quality needle bearings on olympic bars and high quality bushings on powerlifting bar and deadlift bar
- 205,000 PSI tensile strength
- BCOB-2820 Olympic Bar, Black Chrome, 28mm, 20KG
- HCOB-2820 Olympic Bar, Hard Chrome, 28mm, 20KG
- BCOB-2515 Olympic Bar, Black Chrome, 25mm, 15KG
- HCOB-2515 Olympic Bar, Hard Chrome, 25mm, 15KG



EZ CURL BAR

- Length: 1200mm
- Shaft and Sleeve Coating: Hard Chrome
- Sleeve Rotation: bushing
- Diameter: 30mm
- Weight: 10kg
- Sleeve Length: 162mm
- Fits Standard Olympic size discs
- HCCB-3010 EZ Curl Bar, Hard Chrome, 4', 9.7KG



POWER LIFT & DEADLIFT BAR

- Fits standard Olympic size discs
- Premium hard chrome coated 17.5" sleeves
- Needle bearings for smooth and even rotation during lifts
- Capped ends for reduced maintenance
- 2000lb load capacity
- HCOB-2920 Powerlifting Bar, Hard Chrome, 29mm, 20KG
- BCOB-2720 Deadlift Bar, Black Chrome, 27mm, 20KG



HEX TRAP BAR

- Length: 1405mm
- Shaft and Sleeve Coating: Hard Chrome
- Diameter: 25mm
- Weight: 22KG
- Medium Knurled handles
- Fits standard Olympic size discs
- HCTB-2522 Hex Trap Bar, Hard Chrome, 22KG

FUNCTIONAL TRAINING

For 20 years, Throwdown has offered unique workout opportunities that add diversity and challenge to any exercise routine. From functional training zones and innovative equipment that optimize movement efficiency, to boxing, mixed martial arts and more, Throwdown products are the differentiator in any fitness studio.

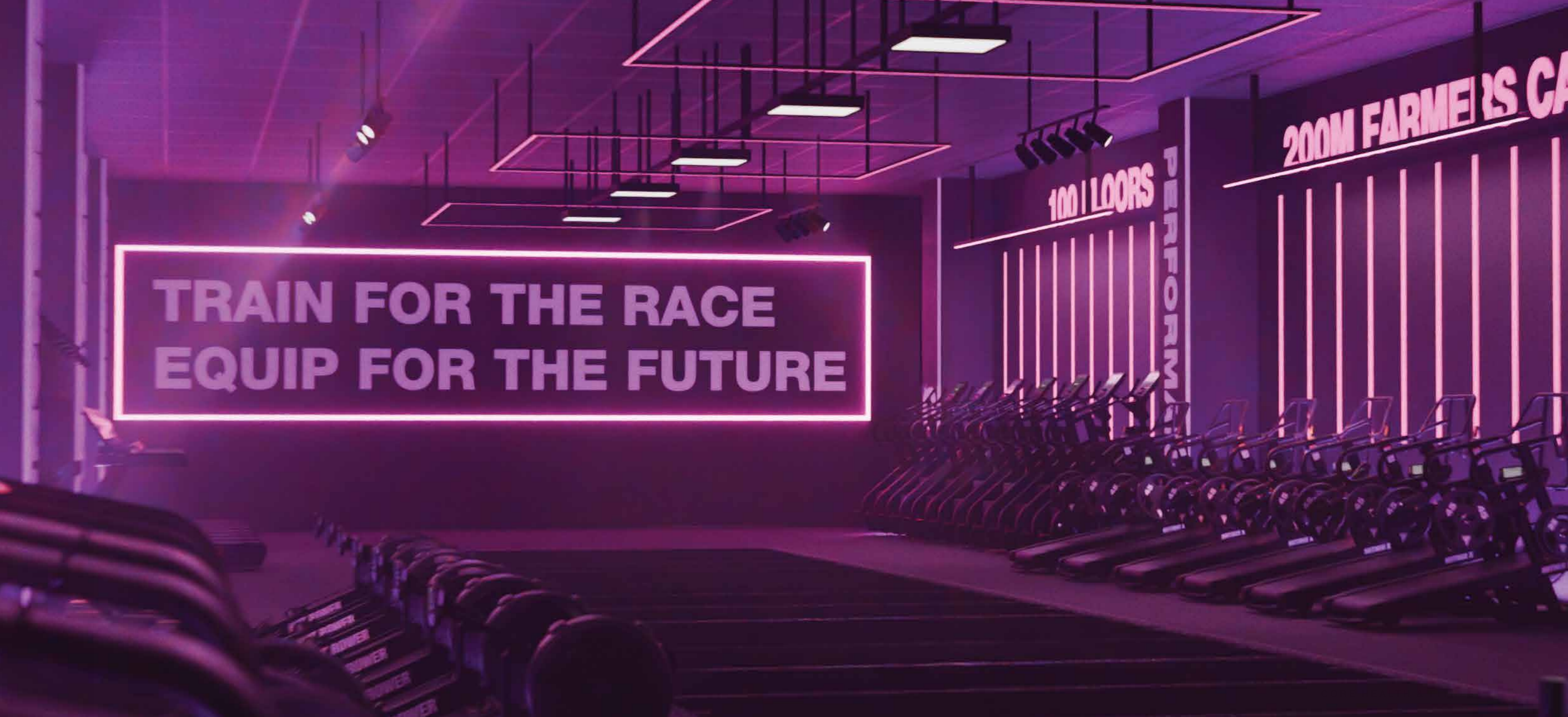

FUNCTIONAL TRAINING

Throwdown - Alpha XTC Rigs



Personal Training Center 9-PTC-60THD

LENGTH	290 in (737 cm)
WIDTH	235 in (598 cm)
HEIGHT	105 in (267 cm)
RECOMMENDED FLOOR SPACE	24' x 26' (7.3 x 7.9 m)
CONSTRUCTION	11-gauge steel, 3"x6" (7.5cm x 15cm) tubing
FinISH	Electrostatic Powder coating



Functional Strength Station 9-WR1-60THD

LENGTH	60 (153 cm)
WIDTH	54 in (139 cm)
HEIGHT	105 in (268 cm)
RECOMMENDED FLOOR SPACE	14' x 14' (4.27m x 4.27m)
CONSTRUCTION	11-gauge steel, 3"x6" (7.5cm x 15cm) tubing
FinISH	Electrostatic Powder coating

*Accessories not included



Functional Core Station 9-WR2-60THD

LENGTH	69 in (175 cm)
WIDTH	56 in (144 cm)
HEIGHT	105 in (268 cm)
RECOMMENDED FLOOR SPACE	14' x 14' (4.27m x 4.27m)
CONSTRUCTION	11-gauge steel, 3"x6" (7.5cm x 15cm) tubing
FinISH	Electrostatic Powder coating

*Accessories not included

[Check out page 78 to see our shorter AXTC - Suitable for our Light Commercial Solutions](#)

Throwdown - Alpha XTC Accessories



4' Core 73-00221-60

LENGTH	46 in (116 cm)
WIDTH	48 in (123 cm)
HEIGHT	105 in (267 cm)
CONSTRUCTION	11-gauge steel, 3"x6" (7.5cm x 15cm) tubing
FinISH	Electrostatic Powder coating



4' Add-On 73-00190-60

LENGTH	46 in (116 cm)
WIDTH	45 in (118 cm)
HEIGHT	105 in (267 cm)
CONSTRUCTION	11-gauge steel, 3"x6" (7.5cm x 15cm) tubing
FinISH	Electrostatic Powder coating



20' Bridge 73-00222-60

LENGTH	225 in (572 cm)
WIDTH	57 in (146 cm)
HEIGHT	105 in (267 cm)
CONSTRUCTION	11-gauge steel, 3"x6" (7.5cm x 15cm) tubing
FinISH	Electrostatic Powder coating



16' Bridge 73-00223-60

LENGTH	177 in (450 cm)
WIDTH	57 in (146 cm)
HEIGHT	105 in (267 cm)
CONSTRUCTION	11-gauge steel, 3"x6" (7.5cm x 15cm) tubing
FinISH	Electrostatic Powder coating

FUNCTIONAL TRAINING

Alpha XTC Attachments



WIDE SHELF, 4'
SKU: 52-00124-60-KT



WIDE SHELF, 6'
SKU: 52-00125-60-KT



STABILITY BALL SHELF, 6'
SKU: 52-00156-60-KT



DUMBBELL SHELF, 6'
SKU: 73-00266-60-KT



DUMBBELL SHELF, 4'
SKU: 73-00280-60-KT

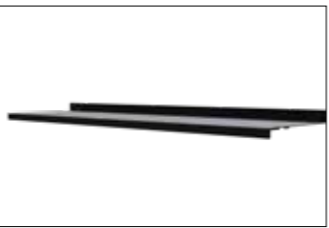

PLYO SHELF
SKU: 52-00158-60-KT



BARBELL STORAGE
SKU: 73-00239-60-KT



BALANCE BALL
SKU: 73-00191-60-KT



ROPE ANCHOR RIG MOUNT
SKU: 71-00308-60-KT



SQUAT STATION
SKU: 73-00151-60-KT



ATTACHMENT POINT
SKU: 72-00108-60-KT



LANDMINE RIG MOUNT
SKU: 71-00227-60-KT

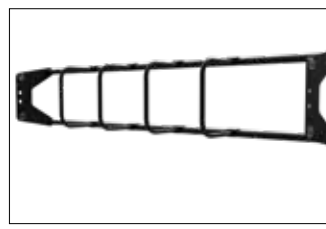

ROLLER STORAGE KIT, 6'
SKU: 73-00197-60-KT

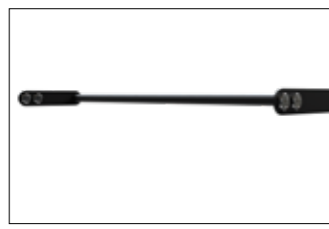

ROLLER CONTAINMENT, 4'
SKU: 73-00196-60-KT

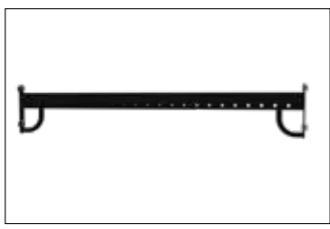

XTC CROSSMEMBER, 6'
SKU: 52-00114-60-KT

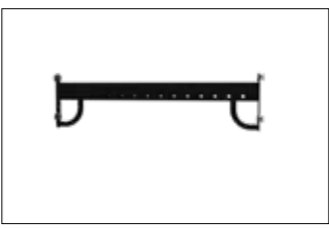

XTC CROSSMEMBER, 4'
SKU: 52-00113-60-KT



PLATE STORAGE, 6'
SKU: 73-00242-60-KT



PLATE STORAGE, 4'
SKU: 71-00363-60-KT



BAR STORAGE
SKU: 71-00267-60-KT

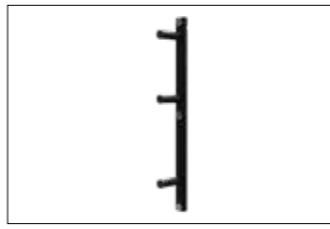

WEIGHT PLATE STORAGE HANGER
SKU: 73-00162-60-KT



PULL UP BAR ADD-ON
SKU: 73-00192-60-KT



BAG HANGER
SKU: 73-00158-60-KT

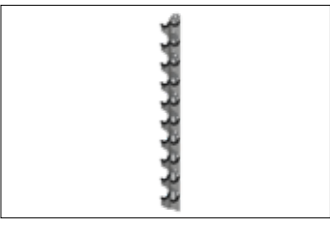

VERTICAL DUMBBELL RACK
SKU: 71-00367-29-KT



ROPE HANGER, PTC
SKU: 73-00194-60-KT



LOCKING DRAWER, 4'
SKU: 73-00268-60-KT



LOCKING DRAWER, 6'
SKU: 73-00269-60-KT

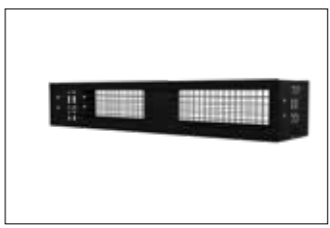

STORAGE BIN, 6'
SKU: 52-00127-60-KT



STORAGE BIN, 4'
SKU: 71-00402-60-KT



STORAGE PIN
SKU: 52-00139-60-KT



STORAGE PEG
SKU: 71-00357-60-KT

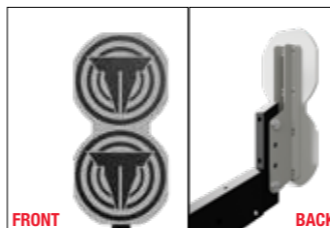

COMPETITION BALL TARGET
SKU: 73-00411-29THD-KT

FUNCTIONAL TRAINING

Throwdown XTC Rigs



XTC 2x4 Compact 9-XTC-204C-60THD

RECOMMENDED FLOOR SPACE 14' X 12' (4.5M X 4M)

INCLUDES:

- BALL SHELF, 4' X1
- BAR STORAGE X1
- PLATE STORAGE, 4' X1
- SQUAT STATION X1
- WIDE SHELF, 4' X1



XTC 4x4 Compact 9-XTC-404C-60THD

RECOMMENDED FLOOR SPACE 14' X 14' (4.5M X 4.5M)

INCLUDES:

- BALL SHELF, 4' X1
- BAR STORAGE X1
- PLATE STORAGE, 4' X1
- SQUAT STATION X1
- WIDE SHELF, 4' X2



XTC 2x8 Compact 9-XTC-208C-60THD

RECOMMENDED FLOOR SPACE 18' X 12' (5.5M X 4M)

INCLUDES:

- TRIANGLE PULL UP BAR X1
- DIP BAR X1
- WIDE SHELF, 4' X6

XTC 4x14 Standard 9-XTC-414C-60THD

RECOMMENDED FLOOR SPACE 14' X 24' (4.26 X 7.32M)

INCLUDES:

- BALL SHELF, 4' X4
- BAR STORAGE X2
- PLATE STORAGE, 4' X2
- LANDMINE, RIG MOUNT X2
- ROPE ANCHOR, RIG MOUNT X2
- STORAGE BIN, 6' X1
- STORAGE PIN X4
- SQUAT STATION, 4' X2
- TARGET + DPU ADAPTER X2
- VERTICAL DUMBBELL RACK X2
- WIDE SHELF, 4' X2
- XTC CROSSMEMBER, 6' X1

XTC 4X24 STANDARD 9-XTC-424C-60THD

RECOMMENDED FLOOR SPACE 14' X 34' (4.26 X 10.36M)

INCLUDES:

- BALL SHELF, 4' X4
- BAR STORAGE X2
- DIP BAR X2
- LANDMINE, RIG MOUNT X2
- MEGA GRIP PULLUP BAR, 4' X1
- MUSCLE UP ATTACHMENT X1
- NEUTRAL GRIP PULLUP X2
- PLATE STORAGE, 4' X2
- ROPE ANCHOR, RIG MOUNT X2
- STORAGE BIN, 6' X2
- STORAGE PIN X8
- SQUAT STATION, 4' X2
- TARGET + DPU ADAPTER X2
- VERTICAL DUMBBELL RACK X2
- WIDE SHELF, 4' X6
- XTC CROSSMEMBER, 6' X2

XTC 4X34 STANDARD 9-XTC-434C-60THD

RECOMMENDED FLOOR SPACE 14' X 44' (4.26 X 13.41M)

INCLUDES:

- BALL SHELF, 4' X8
- BAR STORAGE X4
- LANDMINE, RIG MOUNT X4
- NEUTRAL GRIP PULLUP X1
- PLATE STORAGE, 4' X4
- ROCK GRIP PULLUP X1
- ROPE ANCHOR, RIG MOUNT X4
- STORAGE BIN, 6' X2
- STORAGE PIN X8
- SQUAT STATION, 4' X4
- TARGET + DPU ADAPTER X4
- VERTICAL DUMBBELL RACK X2
- WIDE SHELF, 4' X4
- WIDE SHELF, 6' X3
- XTC CROSSMEMBER, 6' X2

*PICTURED ABOVE

CUSTOM COLORS

We know what it takes to build an authentic, meaningful brand experience. Our customization program is the perfect way to leverage your personal brand and make a strong first impression. Get Throwdown XTC rigs in a variety of custom color options.



BLACK -60



SILVER - 29



KARMINROT -30



ULTRAMARINE BLUE -73



GALVANIZED -01

FUNCTIONAL TRAINING

Throwdown - XTC Attachments



DUAL POSTMOUNT LOCATIONS



FLYING PULLUP BAR, 4'
SKU: 51-00246-60-KT
MOUNT: DUAL POST



TRIANGLE PULLUP BAR, 4'
SKU: 51-00252-60-KT
MOUNT: DUAL POST



ROCK GRIP PULLUP
SKU: 71-00229-60-KT
MOUNT: DOUBLE PULLUP BAR



NEUTRAL GRIP PULLUP
SKU: 71-00268-60-KT
MOUNT: DOUBLE PULLUP BAR

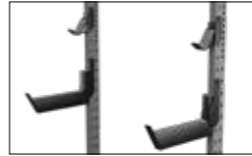

SQUAT STATION
SKU: 73-00120-60-KT
MOUNT: DUAL POST

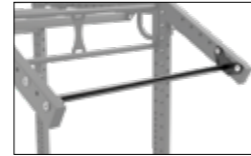

MEGA GRIP PULLUP BAR, 4'
SKU: 51-00293-60-KT
MOUNT: MUSCLEUP/POST

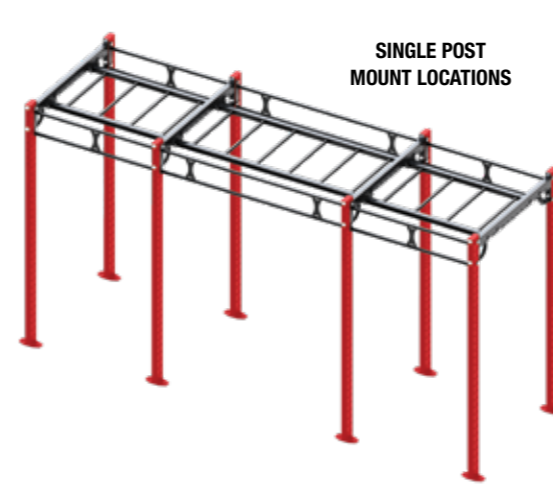

SINGLE POST MOUNT LOCATIONS



UNIVERSAL CLIP ATTACHMENT
SKU: 72-00108-60-KT
MOUNT: POST



STEP-UP
SKU: 71-00100-60-KT
MOUNT: POST



DIP BAR
SKU: 71-00101-60-KT
MOUNT: POST



LANDMINE, RIG MOUNT
SKU: 71-00227-60-KT
MOUNT: POST



BAR STORAGE
SKU: 71-00267-60-KT
MOUNT: POST

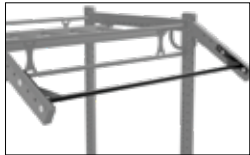

MEGA GRIP PULLUP BAR, 6'
SKU: 51-00314-60-KT
MOUNT: MUSCLEUP/POST



TARGET + DPU ADAPTER
SKU: 73-00121-29THD-KT
MOUNT: DOUBLE PULLUP BAR



XTC CROSSMEMBER, 6'
SKU: 52-00114-60-KT
MOUNT: DUAL POST



XTC CROSSMEMBER, 4'
SKU: 52-00113-60-KT
MOUNT: DUAL POST



WIDE SHELF, 6'
SKU: 52-00125-60-KT
MOUNT: DUAL POST



WIDE SHELF, 4'
SKU: 52-00124-60-KT
MOUNT: DUAL POST



BALL SHELF, 4'
SKU: 71-00271-60-KT
MOUNT: DUAL POST



ROPE HANGER
SKU: 71-00360-60-KT
MOUNT: POST

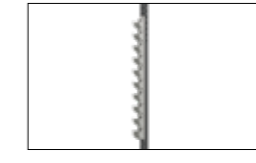

VERTICAL DUMBBELL RACK
SKU: 71-00367-60-KT
MOUNT: POST



ROPE ANCHOR, RIG MOUNT
SKU: 71-00308-60-KT
MOUNT: POST



STORAGE PEG
SKU: 71-00357-60-KT
MOUNT: POST

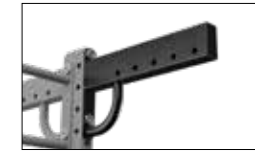

CROSSMEMBER EXTENSION
SKU: 52-00144-60-KT
MOUNT: POST



KETTLEBELL SHELF, 4'
SKU: 73-00122-60-KT
MOUNT: DUAL POST



PLATE STORAGE, 4'
SKU: 71-00363-60-KT
MOUNT: DUAL POST



STABILITY BALL SHELF, 6'
SKU: 52-00156-60-KT
MOUNT: DUAL POST



PLYO SHELF, 6'
SKU: 73-00128-60-KT
MOUNT: DUAL POST



PLATE STORAGE, 6'
SKU: 73-00242-60-KT
MOUNT: DUAL POST



DUMBBELL SHELF, 4'
SKU: 73-00280-60-KT
MOUNT: DUAL POST



DUMBBELL SHELF, 6'
SKU: 73-00266-60-KT
MOUNT: DUAL POST



MUSCLE UP ATTACHMENT
SKU: 52-00122-60-KT
MOUNT: DUAL POST



TARGET
SKU: 72-00133-29THD-KT
MOUNT: POST

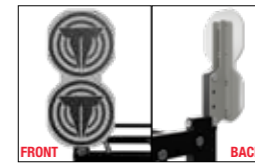

COMPETITION BALL TARGET
SKU: 73-00410-29THD-KT
MOUNT: POST



HEX BARBELL STORAGE KIT
SKU: 73-00239-60-KT
MOUNT: POST

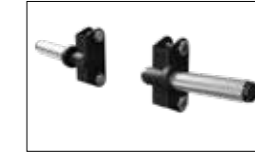

XTC WEIGHT HORN (LEFT, RIGHT)
SKU: 72-00142-XX-KT (LEFT)
72-00143-XX-KT (RIGHT)
MOUNT: POST



LOCKING DRAWER, 4'
SKU: 73-00268-60-KT
MOUNT: DUAL POST



LOCKING DRAWER, 6'
SKU: 73-00269-60-KT
MOUNT: DUAL POST



LOCKABLE BIN, 4'
SKU: 73-00282-60-KT
MOUNT: DUAL POST



LOCKABLE BIN, 6'
SKU: 73-00283-60-KT
MOUNT: DUAL POST



STORAGE BIN, 4'
SKU: 71-00402-60-KT
MOUNT: DUAL POST



STORAGE BIN, 6'
SKU: 52-00127-60-KT
MOUNT: DUAL POST

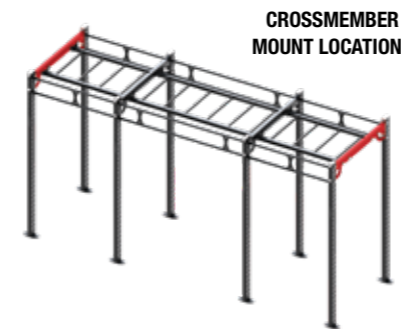

CROSSMEMBER MOUNT LOCATIONS



TARGET
SKU: 72-00133-29THD-KT
MOUNT: CROSSMEMBER



STORAGE PIN
SKU: 52-00139-60-KT
MOUNT: CROSSMEMBER



BAG HANGER
SKU: 71-00323-60-KT
MOUNT: CROSSMEMBER

FUNCTIONAL TRAINING

Throwdown



XTR™ Storage

Throwdown XTR Storage is built to be both functional and durable. Simple intricate designs keep the area around the training center clutter free and safe for all members. Each piece provides a specific storage solution for all of your functional training accessories.

Throwdown FXD Bench

The FXD Bench is a multi-functional bench with integrated storage. The bench was designed for efficient use with a live or virtual on-screen instructor. It allows most exercises to be accomplished while facing the instructor. The layout of the bench and modular attachment points facilitate quick transitions between exercises.



Shown with optional Knux FXD Bench Set (Sku: TD-KNX-FXD-SET) which includes a set of 1lb, 2lb and 3lb Knux plus the Knux Holder



XTR STANDARD STORAGE
9-XTR-6061-60



XTR BALL STORAGE
9-XTR-6062-60



XTR SUSPENSION STORAGE
9-XTR-6063-60



STABILITY BALL SHELF, 6'



WIDE SHELF, 6'



XTC CROSSMEMBER, 6'



STORAGE BIN, 6'



STORAGE PIN

LENGTH	44.1 IN (112 CM)
WIDTH	16.5 IN (42 CM)
HEIGHT	16.9 IN (42.9 CM)
INTERNAL STORAGE DIMENSIONS (LXWXD)	5.25 x 23 x 11.5 IN (13.3 x 58.4 x 29.2 CM)
BENCH WEIGHT	138 LB (62.8 KG)
ACCESSORY WEIGHT	164 LB (74.5 KG)
PRODUCT WEIGHT	302 LB (137.2 KG)
SHIPPING WEIGHT	350 LB (159 KG)
STANDARD FRAME COLOR OPTIONS	Black
STANDARD UPHOLSTERY COLOR OPTIONS	Black
CONSTRUCTION	Steel Frame, Molded Foam Cushion

PUSH POSITION



PULL POSITION



LB ACCESSORY KIT:

- (2) 5 lb Dumbbells, (2) 10 lb Dumbbells, (2) 15 lb Dumbbells
- (2) 20 lb Dumbbells, (1) 15 lb Kettlebell,
- (1) 30 lb Kettlebell, (1) 15 lb Slam Ball,
- (2) Level 1 Sleeved Resistance Tubes
- (2) Level 2 Sleeved Resistance Tubes,
- (2) Level 3 Sleeved Resistance Tubes,
- (2) Resistance Tube Handle Attachments,
- (2) Resistance Tube Ankle Attachments

KG ACCESSORY KIT:

- (2) 4 kg Dumbbells, (2) 6 kg Dumbbells, (2) 8 kg Dumbbells
- (2) 10 kg Dumbbells, (1) 8 kg Kettlebell,
- (1) 14 kg Kettlebell, (1) 8 kg Slam Ball,
- (2) Level 1 Sleeved Resistance Tubes
- (2) Level 2 Sleeved Resistance Tubes,
- (2) Level 3 Sleeved Resistance Tubes,
- (2) Resistance Tube Handle Attachments,
- (2) Resistance Tube Ankle Attachments

IMPACT SPORTS

Designed to meet the rigorous demands of athletes and enthusiasts alike, Throwdown offers premium training equipment, including striking bags, functional rigs, and versatile accessories. With a focus on durability, safety, and cutting-edge design, Throwdown Impact Sports supports training across disciplines such as mixed martial arts, boxing, and high-intensity interval training (HIIT). By blending high-quality materials with expert craftsmanship, Throwdown empowers users to push their limits, achieve their goals, and make an impact in every workout.



IMPACT SPORTS

Throwdown - SSTT



*OPTIONAL LAYOUT EXAMPLE

Throwdown Single Station Training Tree

Throwdown's Single Station Training Tree is a space efficient solution to offer impact fitness in any facility. This floor mounted bag rack can be used as a SINGLE unit in an open gym layout or as a series in a row to create the perfect group exercise experience. The Throwdown SSTT bag racks blend the best of impact sports and functional training to help members meet their goals.



SSTT 9-SSTT-60

LENGTH	46.2" (117.3 CM)
WIDTH	12" (20.5 CM)
HEIGHT	96.2" (244.4 CM)
RECOMMENDED FLOOR SPACE	4' x 7' (122 CM x 213 CM)
CONSTRUCTION	7-gauge steel, 4" x 4" (10 cm x 10 cm) tubing
FINISH	Electrostatic Powder Coating
SHIPPING WEIGHT	130 lb (59 kg)
SHIPPING DIMENSIONS	96.5" x 42.25" x 12" (245 cm x 107 cm x 30.5 cm)

OPTIONAL ATTACHMENTS



MEGA GRIP PULL UP BAR, 4'
SKU: 51-00293-60-KT



BALLET BAR SET, 4'
SKU: 73-00187-60



BALLET BAR ADD-ON SET, 4'
SKU: 73-00188-60

COLOR CUSTOMIZATION

We know what it takes to build an authentic, meaningful brand experience. Our customization program is the perfect way to leverage your personal brand and make a strong first impression. Get Throwdown Single Station Training Tree in a variety of custom color options.



BLACK -60



SILVER - 29



KARMINROT -30



ULTRAMARINE BLUE -73

IMPACT SPORTS

Throwdown - FBR



*OPTIONAL LAYOUT EXAMPLE

FBR 6x12 9-FBR-0612-60

LENGTH	153.95" (391 CM)
WIDTH	81.95" (208 CM)
HEIGHT	102" (259 CM)
RECOMMENDED FLOOR SPACE	11' X 17' (3.35 M X 5.18 M)
BAG SPACING	4.5' (137 CM)
CONSTRUCTION	7-GAUGE STEEL, 4"x4" (10CM X 10CM) TUBING
FINISH	ELECTROSTATIC POWDER COATING

FBR 6x24 9-FBR-0624-60

LENGTH	297.9" (756.7 CM)
WIDTH	81.95" (208 CM)
HEIGHT	102" (259 CM)
RECOMMENDED FLOOR SPACE	11' X 29' (3.35 X 8.8 M)
BAG SPACING	4.5' (137 CM)
CONSTRUCTION	7-GAUGE STEEL, 4"x4" (10CM X 10CM) TUBING
FINISH	ELECTROSTATIC POWDER COATING

FBR 12x12 9-FBR-1212-60

LENGTH	153.95" (391CM)
WIDTH	153.95" (391CM)
HEIGHT	102" (259 CM)
RECOMMENDED FLOOR SPACE	17' X 17' (5.2 X 5.2 M)
BAG SPACING	4.5' (137 CM)
CONSTRUCTION	7-GAUGE STEEL, 4"x4" (10CM X 10CM) TUBING
FINISH	ELECTROSTATIC POWDER COATING



FBR 12x24 9-FBR-1224-60

Length	297.9" (756.7CM)
Width	153.95" (391CM)
Height	102" (259CM)
Recommended Floor Space	17' X 29' (5.2 X 8.8 M)
Bag Spacing	4.5' (137 cm)
Construction	7-gauge steel, 4"x4" (10cm x 10cm) tubing
Finish	Electrostatic Powder coating



FBR 24x24 9-FBR-2424-60

Length	297.9" (756.7 CM)
Width	297.9" (756.7 CM)
Height	102" (259 CM)
Recommended Floor Space	29' X 29' (8.8 X 8.8 M)
Bag Spacing	4.5' (137 cm)
Construction	7-gauge steel, 4"x4" (10cm x 10cm) tubing
Finish	Electrostatic Powder coating

optional attachments

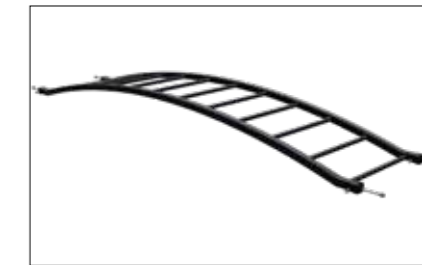

MONKEY BARS
SKU: 71-00143-60
MOUNT: CROSSMEMBER



PULL UP
SKU: 71-00377-60
MOUNT: CROSSMEMBER



ADD-ON BEAM
SKU: 73-00130-60
MOUNT: CROSSMEMBER

IMPACT SPORTS

Throwdown - ABR



9x18 ABR 8-Bag 9-ABR-1808-60

LENGTH	226" (574 CM)
WIDTH	118" (300 CM)
HEIGHT	107" (271 CM)
RECOMMENDED FLOOR SPACE	19' X 28' (5.8 X 8.5 M)
BAG SPACING	4.5' (137 CM)
BAG POSITIONS	8
CONSTRUCTION	7-GAUGE STEEL, 4"X 4" (10CM X 10CM) TUBING
FINISH	ELECTROSTATIC POWDER COATING

9x18 ABR 12-Bag 9-ABR-1812-60

LENGTH	267" (680 CM)
WIDTH	118" (300 CM)
HEIGHT	107" (271 CM)
RECOMMENDED FLOOR SPACE	19' X 32' (5.8 X 9.8 M)
BAG SPACING	4.5' (137 CM)
BAG POSITIONS	12
CONSTRUCTION	7-GAUGE STEEL, 4"X 4" (10CM X 10CM) TUBING
FINISH	ELECTROSTATIC POWDER COATING

9x18 ABR 16-Bag 9-ABR-1816-60

LENGTH	267" (680 CM)
WIDTH	152" (386 CM)
HEIGHT	107" (271 CM)
RECOMMENDED FLOOR SPACE	22' X 32' (6.7 X 9.8 M)
BAG SPACING	4.5' (137 CM)
BAG POSITIONS	16
CONSTRUCTION	7-GAUGE STEEL, 4"X 4" (10CM X 10CM) TUBING
FINISH	ELECTROSTATIC POWDER COATING



9x36 ABR 16-Bag 9-ABR-3616-60

LENGTH	441" (1122 CM)
WIDTH	118" (300 CM)
HEIGHT	107" (271 CM)
RECOMMENDED FLOOR SPACE	19' x 46' (5.8 x 14 M)
BAG SPACInG	4.5' (137 cm)
BAG POSITIONS	16
CONSTRUCTION	7-gauge steel, 4"x 4" (10cm x 10cm) tubing
FinISH	Electrostatic Powder Coating



9x36 ABR 24-Bag 9-ABR-3624-60

LENGTH	484" (1228 CM)
WIDTH	152" (386 CM)
HEIGHT	107" (271 CM)
RECOMMENDED FLOOR SPACE	22' x 50' (6.7 x 15.2 M)
BAG SPACInG	4.5' (137 cm)
BAG POSITIONS	24
CONSTRUCTION	7-gauge steel, 4"x 4" (10cm x 10cm) tubing
FinISH	Electrostatic Powder Coating



9x36 ABR 20-Bag 9-ABR-3620-60

LENGTH	484" (1228 CM)
WIDTH	118" (300 CM)
HEIGHT	107" (271 CM)
RECOMMENDED FLOOR SPACE	19' x 50' (5.8 x 15.2 M)
BAG SPACInG	4.5' (137 cm)
BAG POSITIONS	20
CONSTRUCTION	7-gauge steel, 4"x 4" (10cm x 10cm) tubing
FinISH	Electrostatic Powder Coating



9x36 ABR 28-Bag 9-ABR-3628-60

LENGTH	484" (1228 CM)
WIDTH	152" (386 CM)
HEIGHT	107" (271 CM)
RECOMMENDED FLOOR SPACE	22' x 50' (6.7 x 15.2 M)
BAG SPACInG	4.5' (137 cm)
BAG POSITIONS	28
CONSTRUCTION	7-gauge steel, 4"x 4" (10cm x 10cm) tubing
FinISH	Electrostatic Powder Coating



9x18 ABR 20-Bag 9-ABR-1820-60

LENGTH	267" (680 CM)
WIDTH	152" (386 CM)
HEIGHT	107" (271 CM)
RECOMMENDED FLOOR SPACE	22' x 32' (6.7 x 9.8 M)
BAG SPACInG	4.5' (137 cm)
BAG POSITIONS	20
CONSTRUCTION	7-gauge steel, 4"x 4" (10cm x 10cm) tubing
FinISH	Electrostatic Powder Coating



9x36 ABR 36-Bag 9-ABR-3636-60

LENGTH	484" (1228 CM)
WIDTH	152" (386 CM)
HEIGHT	107" (271 CM)
RECOMMENDED FLOOR SPACE	22' x 50' (6.7 x 15.2 M)
BAG SPACInG	4.5' (137 cm)
BAG POSITIONS	36
CONSTRUCTION	7-gauge steel, 4"x 4" (10cm x 10cm) tubing
FinISH	Electrostatic Powder Coating

IMPACT SPORTS

Throwdown



FEATURES:

Versatile Base: Weighted base includes integrated handles for use as footholds during abdominal exercises and handholds for various workouts. These handles also serve as anchor points for resistance bands, straps, and battle ropes. The base can be filled with water, aqueous gel, sand, or steel shot for stability.

Advanced Shock Absorption: A dampening tank and elastic diaphragm reduce impact (absorbing stikes), prevent tipping with enhanced balance, and minimize injury risk.

Freestanding Punching Bag
9-TD-FHB1-35THD

HEIGHT	67" (171cm)
WIDTH	24" (61cm)
LENGTH	24" (61cm)
MACHINE WEIGHT	117 lbS (18.9 kg)



BoxMaster PRO 9BM-K9601

HEIGHT	82 in (208 cm)
WIDTH	33 in (84 cm)
LENGTH	30 in (76 cm)
MACHINE WEIGHT	222 lb (100 kg)



Boxmaster PRO Quad 9BM-K9604

HEIGHT	82 in (208 cm)
WIDTH	75 in (185 cm)
LENGTH	73 in (183 cm)
MACHINE WEIGHT	1214lb (551 kg)



BASEPLATE 400-1120

OPTIONAL



KICK PAD 731-5674



Dual Base 9BM-K9405

HEIGHT	11.7 in (29 cm)
WIDTH	42.9 in (108.8 cm)
LENGTH	109.6 in (278.5 cm)



Stance Mat 731-9445

HEIGHT	.12 in (3 mm)
WIDTH	51 in (1295 mm)
LENGTH	106 in (2692 mm)



Education Stand 9-BMES-60ENG

HEIGHT	58.7 in (1492 mm)
WIDTH	15.7 in (400 mm)
LENGTH	15.7 in (400 mm)

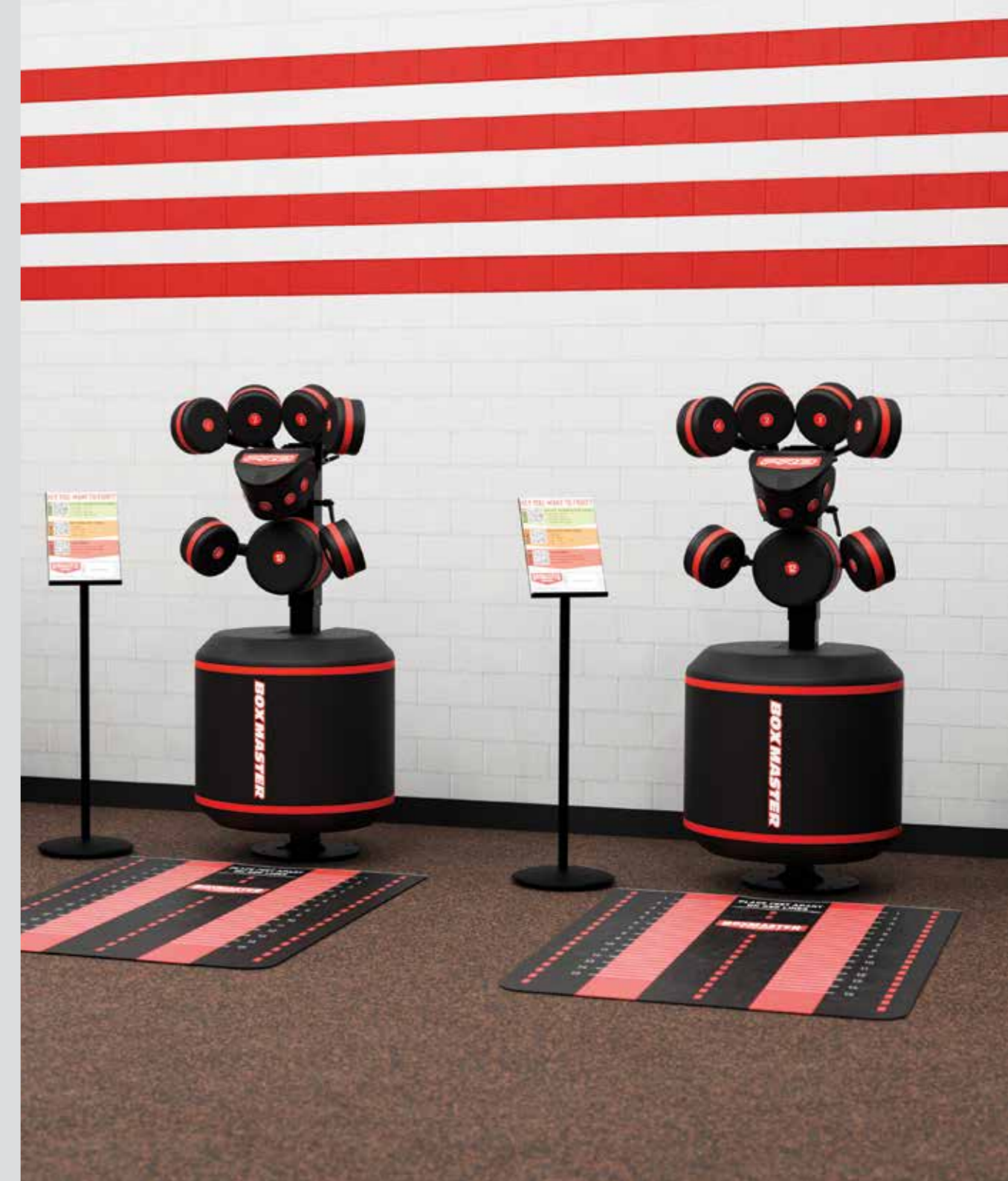

FIT ACCESSORIES

Throwdown



FIT BUMPER PLATES (LB)

- Made of rubber, minimizing gym noise
- Durable stainless-steel insert
- Color coded
- Sold individually
- SKU: 10 lb Green (TD-BP-10)
- SKU: 25 lb Yellow (TD-BP-25)
- SKU: 35 lb Blue (TD-BP-35)
- SKU: 45 lb Red (TD-BP-45)



FIT BUMPER PLATES (KG)

- Made of rubber, minimizing gym noise
- Durable stainless-steel insert
- Black/White
- Sold individually
- SKU: 5 kg (TD-BP-5kg)
- SKU: 10 kg (TD-BP-10kg)
- SKU: 15 kg (TD-BP-15kg)
- SKU: 20 kg (TD-BP-20kg)



FIT BUMPER PLATES (LB)

- Made of rubber, minimizing gym noise
- Durable stainless-steel insert
- Available in pounds only
- Color coded
- Sold individually
- SKU: 10 lb Green (FIT-BMPPLT-10lb-GRN)
- SKU: 25 lb Yellow (FIT-BMPPLT-25lb-YLW)
- SKU: 35 lb Blue (FIT-BMPPLT-35lb-BLU)
- SKU: 45 lb Red (FIT-BMPPLT-45lb-RED)



OLYMPIC BARS

- 15 kg - 25 mm diameter
- 20kg - 28 mm diameter
- Standard Olympic Knurl marks
- Two weights
- Black zinc bar w/ hard chrome bar ends
- Sold individually
- SKU: 15kg (TD-OB-15kg)
- SKU: 20kg (TD-OB-20kg)



SUPER SLEDS

- Sturdy, steel construction
- Multi-directional design for partner training
- Multiple grip options
- Collapsible
- Silver/Black
- Sold individually
- SKU: 71-00432



SLED / CLIMBING ROPES

- Heavy-duty, woven rope
- Secured hand grips on both ends
- 15' & 20' full length ropes
- Available in 1.5" diameter
- Black
- Sold individually
- SKU: 1.5" x 15' (TD-CLR-1.5)
- SKU: 1.5" x 20' (TD-SLR-1.5)



BATTLE ROPES

- Heavy-duty, woven rope
- Secured hand grips on both ends
- Available in 20' & 30' Length
- Black
- Sold individually
- SKU: 1.5" x 20' (TD-BTR-20-1.5)
- SKU: 1.5" x 30' (TD-BTR-1.5)
- SKU: 2" x 30' (TD-BTR-2)



ROPE ANCHORS

- instrumental partner component for every battle rope
- Steel Construction
- Mounts to floor
- Black
- Sold individually
- SKU: [A] Standing Rope Anchor w/ Storage (52-00118-60)
- SKU: [B] Floor Mount Rope Anchor (TD-FRPA)

FIT ACCESSORIES

Throwdown



3-N-1 POWER PLYOS

- Sturdy foam core provides the perfect jump platform
 - Durable vinyl cover
- Provides 20", 24" and 30" jump heights
- Black/Color coded height designation
- Sold individually

SKU: TD-PB-3N1-C



POWER PLYO SETS

- Firm foam boxes are stackable, providing seven jump heights (6", 12", 18", 24", 30", 36" and 42".)
 - Three individual boxes measuring 6", 12" and 24"
- Durable vinyl cover with a wide 30"x36" base
 - Boxes attach with Velcro connections
 - Black/Color coded height designation
- Sold in sets

SKU: TD-PB-SET-C

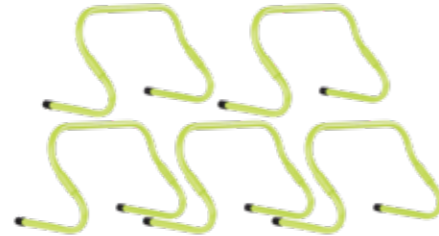

ADJUSTABLE SPEED HURDLES

- Made of durable PVC
- 2 height adjustments, 7" & 12"
 - Bright green
- Sold in sets of 5

SKU: TD-ASH

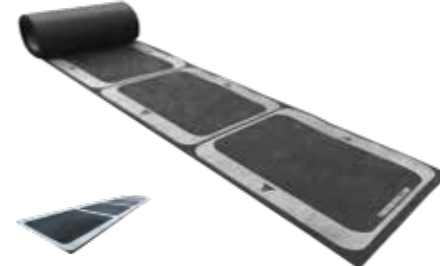

AGILITY LADDERS

- Premium black recycled rubber
- Improve speed, agility, balance and coordination
 - 16' x 15"
 - Black/Grey
- Sold individually

SKU: TD-AGL



DYNAMIC RESISTANCE BANDS

- Made of latex, each band varies in color, width, thickness and tension for specialized training
- Sold individually
- SKU: Level 1 - 1/2" Red (TD-RB-L1)
- SKU: Level 2 - 3/4" Black (TD-RB-L2)
- SKU: Level 3 - 1 1/4" Purple (TD-RB-L3)
- SKU: Level 4 - 1 3/4" Green (TD-RB-L4)
- SKU: Level 5 - 2 1/2" Blue (TD-RB-L5)
- SKU: Level 6 - 3 1/4" Orange (TD-RB-L6)



MINI RESISTANCE BANDS

- Each band varies in color, thickness & tension for specialized training.
- 2" wide x 12" diameter, made of latex
- Sold in sets of 5
- SKU: Assorted Set - One Each (TD-MRB-SET)
- SKU: Level 1 - Yellow (TD-MRB-L1-SET)
- SKU: Level 2 - Green (TD-MRB-L2-SET)
- SKU: Level 3 - Blue (TD-MRB-L3-SET)
- SKU: Level 4 - Black (TD-MRB-L4-SET)
- SKU: Level 5 - Red (TD-MRB-L5-SET)



SLEEVED RESISTANCE TUBING

- Padded, textured handles for a firm, comfortable grip
- Five tensions
- Grey/Color coded
- Sold individually
- SKU: Level 1 Orange (TD-ST-L1)
- SKU: Level 2 Black (TD-ST-L2)
- SKU: Level 3 Purple (TD-ST-L3)
- SKU: Level 4 Green (TD-ST-L4)
- SKU: Level 5 Blue (TD-ST-L5)

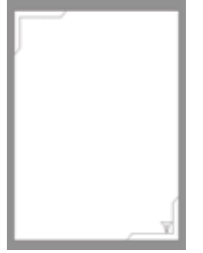

HIIT INTERVAL WHITE BOARD MAGNETS

- White dry erase magnets provide a simple way to set up your station workouts
- Mountable to all steel surfaces
 - 4" x 6"
 - White
- Sold in sets of 20

SKU: 91-00202



AGILITY DOTS

- Soft, flexible, plastic non-slide markers
- 7" diameter
- Black/Grey
- Sold in sets of 12

SKU: TD-DOT-SET



AGILITY CONES

- Stackable & Lightweight
- Improve speed, agility, balance and coordination
 - 5" x 1.25"
 - Light Grey
- Sold in sets of 10

SKU: TD-AC



EXERCISE MATS

- Closed cell foam is light and resilient
- Includes eyelets for hanging storage
- Provides a base for comfortable floor exercises and stretching
 - Black
- Sold individually
- SKU: 21" x 48" (TD-EXM-48)
- SKU: 21" x 66" (TD-EXM-66)



FOAM ROLLERS

- High density foam
- Therapeutic benefits
- Roller maintains its form and feel
- Two sizes available: 18" and 36" long
 - Black
- Sold individually
- SKU: 18" (TD-FMR-18)
- SKU: 36" (TD-FMR-36)



4' HEAVY BAGS

- T-Flex Tarpoline shell with industrial fiber fill
- Nylon, adjustable, webbed hanging straps
- Heavy bag hardware kit is included with each bag, made from custom premium wear resistant steel.
- 16" x 48" / 100 lb.
- Black
- Sold individually

SKU: TD-HB-4



6' HEAVY BAGS

- T-Flex Tarpoline shell with industrial fiber fill
- Nylon, adjustable, webbed hanging straps
- Heavy bag hardware kit is included with each bag, made from custom premium wear resistant steel.
- 14" x 72" / 120 lbs. Filled
- Black
- Sold individually

SKU(s): TD-HB-6



TEARDROP BAGS

- T-Flex Tarpoline shell with industrial fiber fill
- Nylon, adjustable, webbed hanging straps
- Heavy bag hardware kit included, made from custom premium wear resistant steel.
- 14" x 35" / 75 lb.
- Black
- Sold individually

SKU: TD-TDB



UPPERCUT BAGS

- T-Flex Tarpoline shell with industrial fiber fill
- Nylon, adjustable, webbed hanging straps
- Heavy bag hardware kit included, made from custom premium wear resistant steel.
- 30" x 16" / 70 lb.
- Black
- Sold individually

SKU: TD-UB

FIT ACCESSORIES

Throwdown



WRECKING BALL BAGS

- T-Flex Tarpoline shell with industrial fiber fill
- Nylon, adjustable, webbed hanging straps
- Heavy bag hardware kit included, made from custom premium wear resistant steel.
- Tactical strap included
- 22" x 24" / 100 lb.
- Black
- Sold individually
- SKU: TD-WB



JUMP ROPES

- Rubber rope for speed
- Ergonomically designed handle with internal ball-bearing eliminates rope curling
- Three, color coded lengths
- Sold individually
- SKU: 8' Yellow - (TD-JR-8)
- SKU: 9' Neon Green - (TD-JR-9)
- SKU: 10' Blue - (TD-JR-10)



SPEED ROPES

- Adjustable, black coated wire rope
- Polymer handles with precision ball bearings
- Sold individually
- SKU: TD-SR



OLYMPIC RINGS

- Specifically designed for suspension training
- Complete with nylon straps
- Great for both beginner to expert users
- Wood ring offers a firm, comfortable grip
- Sold in pairs
- SKU: TD-OR



FLOOR SLIDERS

- Efficient design invites multiple bodyweight exercises with maximum range of motion
- For carpet and turf
- Black
- Sold in pairs
- SKU: TD-FLS



PORTABLE LEGEND LANDMINES

- Steel construction
- Conveniently secured using two bumper plates
- Compatible with most barbells
- Black
- Sold individually
- SKU: TD-PLM



STATIONARY LEGEND LANDMINES

- Sturdy steel construction to build core strength
- Bolts to any floor for worry-free stability
- Compatible with most barbells
- Black
- Sold individually
- SKU: 72-00114-60



FACILITY SERIES GROUND-N-POUND DUMMIES

- industrial grade construction with fiber fill
- Webbing overlays reinforced structural seams
- Used for a variety of striking & grappling drills
- 5.6" tall / 90 lb.
- Black
- Sold individually
- SKU: TD-GDM-90



SUSPENSION TRAINERS

- Versatile training kit uses gravity to build muscle, balance and endurance
- includes nylon webbed straps, door anchor and carrying bag
- Black/Grey
- Sold individually
- SKU: TD-SST



STABILITY BALL

- Made of anti-burst vinyl
- Develop abdominal strength and balance
- Ships deflated (pump not included)
- Two sizes: 55cm and 65cm
- Grey
- Sold individually
- SKU: 55 cm (TD-STB-55)
- SKU: 65 cm (TD-STB-65)



BALANCE TRAINER

- Non-skid, rubber platform
- Durable, ribbed half-ball fills with air, facilitating multiple training routines
- 25.5" Diameter
- Air pump included
- Grey/Black
- Sold individually
- SKU: TD-BTP



PREMIUM ABDOMINAL WHEELS

- Simple, yet effective training tool that targets the abs, shoulders and back
- Smooth, 8" rubber wheel with ball bearings
- Padded handles
- 8" x 8" x 11"
- Grey/Black
- Sold individually
- SKU: TD-ABW



FIT DUMMIES

- industrial grade construction with fiber fill
- Practice and perfect a variety of lifts, carries, throws and ground techniques
- Angled design and filling mimics a real body
- Two sizes
- Black
- Sold individually
- SKU: 60 lb (TD-DMY-60-TD)
- SKU: 75 lb (TD-DMY-75-TD)



MEDICINE BALLS

- Functional 14" diameter
 - Reinforced shell and soft fill material provide a balanced shape
 - Available in pounds
 - Black/Grey
 - Sold individually
 - SKUS:
- | | |
|------------------|------------------|
| 5 lb (TD-MB-5) | 15 lb (TD-MB-15) |
| 8 lb (TD-MB-8) | 20 lb (TD-MB-20) |
| 10 lb (TD-MB-10) | 25 lb (TD-MB-25) |



SLAM BALLS (LB)

- Rubberized shell provides a non-slip grip
 - 9" diameter and 11" diameter
 - Available in both pounds & kilograms
 - Black/Grey
 - Sold individually
 - SKUS:
- | | |
|-------------------|-------------------|
| 5 lb(TD-Slb-5) | 30 lb (TD-Slb-30) |
| 10 lb(TD-Slb-10) | 35 lb (TD-Slb-35) |
| 15 lb(TD-Slb-15) | 40 lb (TD-Slb-40) |
| 20 lb(TD-Slb-20) | 45 lb (TD-Slb-45) |
| 25 lb (TD-Slb-25) | 50 lb (TD-Slb-50) |



SLAM BALLS (KG)

- Sturdy foam core provides the perfect jump
 - Rubberized shell provides a non-slip grip
 - 4 - 12 kgs. (9" diameter), 15 kg. (11" diameter)
 - Available in both pounds & kilograms
 - Black/White
 - Sold individually
 - SKUS:
- | | |
|-----------------------|-------------------------|
| +4 kg - (TD-Slb-4kg) | + 10 kg - (TD-Slb-10kg) |
| + 5 kg - (TD-Slb-5kg) | + 12 kg - (TD-Slb-12kg) |
| + 8 kg - (TD-Slb-8kg) | + 15 kg - (TD-Slb-15kg) |

FIT ACCESSORIES

Throwdown



SUPER SAND BAGS

- Hook & loop closure prevents sand leakage
 - Tough, nylon construction
 - Six sizes available
 - One internal bag included
 - Black
 - Sold individually
- SKU: 25-75 lb Unfilled (TD-SB-SM)
SKU: 80-120 lb Unfilled (TD-SB-LG)



HIIT HEX DUMBBELLS (LB)

- Made of latex, each band varies in color, width,
 - Rubber-encased heads minimize noise and floor damage
 - Custom designed and manufactured chrome wear-resistant handles
 - Available in both pounds & kilograms
 - Black/Grey
 - Sold individually
- SKUS:

5 lb (TD-HDB-5)	55 lb (TD-HDB-55)
8 lb (TD-HDB-8)	60 lb (TD-HDB-60)
10 lb (TD-HDB-10)	65 lb (TD-HDB-65)
15 lb (TD-HDB-15)	70 lb (TD-HDB-70)
20 lb (TD-HDB-20)	75 lb (TD-HDB-75)
25 lb (TD-HDB-25)	80 lb (TD-HDB-80)
30 lb (TD-HDB-30)	85 lb (TD-HDB-85)
35 lb (TD-HDB-35)	90 lb (TD-HDB-90)
40 lb (TD-HDB-40)	95 lb (TD-HDB-95)
45 lb (TD-HDB-45)	100 lb (TD-HDB-100)
50 lb (TD-HDB-50)	



HIIT HEX DUMBBELLS (KG)

- Rubber-encased heads minimize noise and floor damage
 - Custom designed and manufactured chrome wear-resistant handles
 - Available in both pounds & kilograms
 - Black/White
 - Sold individually
- SKUS:

2 kg (TD-HDB-2kg)	12.5 kg (TD-HDB-12.5kg)
3 kg (TD-HDB-3kg)	15 kg (TD-HDB-15kg)
4 kg (TD-HDB-4kg)	17.5 kg (TD-HDB-17.5kg)
5 kg (TD-HDB-5kg)	20 kg (TD-HDB-20kg)
6 kg (TD-HDB-6kg)	22.5 kg (TD-HDB-22.5kg)
7 kg (TD-HDB-7kg)	25 kg (TD-HDB-25kg)
8 kg (TD-HDB-8kg)	30 kg (TD-HDB-30kg)
9 kg (TD-HDB-9kg)	
10 kg (TD-HDB-10kg)	



FITNESS KETTLE BELLS

- Powder-coated, balanced, SINGLE-piece casting
- Flat, wobble-free base
- Available in pounds
- Black/Grey
- Sold individually

5 lb (TD-FKB-5)	SKUS: 35 lb (TD-FKB-35)
8 lb (TD-FKB-8)	40 lb (TD-FKB-40)
10 lb (TD-FKB-10)	45 lb (TD-FKB-45)
15 lb (TD-FKB-15)	50 lb (TD-FKB-50)
20 lb (TD-FKB-20)	60 lb (TD-FKB-60)
25 lb (TD-FKB-25)	80 lb (TD-FKB-80)
30 lb (TD-FKB-30)	100 lb (TD-FKB-100)



COMPETITION KETTLE BELLS

- Balanced, SINGLE-piece casting
- Flat, wobble-free base
- Available in kilograms
- Sold individually

SKUS:

8 kg Pink (TD-CKB-8kg)	32 kg Red (TD-CKB-32kg)
12kg L.Blue (TD-CKB-12kg)	36 kg Gray (TD-CKB-36kg)
16 kg Yellow (TD-CKB-16kg)	40 kg White (TD-CKB-40kg)
20 kg Purple (TD-CKB-20kg)	44 kg D. Blue (TD-CKB-44kg)
24 kg Green (TD-CKB-24kg)	48 kg Gold (TD-CKB-48kg)
28 kg Orange (TD-CKB-28kg)	



LIGHT NEO DUMBBELLS

- PVC-encased, minimizing noise
- Available in pounds
- Black/Grey
- Sold individually

SKU: 1 lb (TD-LDB-1)
SKU: 2 lb (TD-LDB-2)
SKU: 3 lb (TD-LDB-3)



KNUX

- Front center weight designed to mimic the weight of boxing gloves
- Ergonomically molded to fit users' hand resulting in a comfortable and secure grip.

SKU: 1 lb (TD-KNX-1)
SKU: 2 lb (TD-KNX-2)
SKU: 3 lb (TD-KNX-3)
SKU: 5 lb (TD-KNX-5)
SKU: 8 lb (TD-KNX-8)



OLYMPIC BAR COLLARS

- SINGLE motion locking mechanism
 - Lightweight and easy to maneuver
 - Black
 - Sold in pairs
- SKU: FIT-OLYCOL-OS-BK



BUMPER PLATE STORAGE CART

- Sturdy, steel construction minimizes vibration and noise
 - Stores Bumper Plates & Bars
 - Efficient, portable design
 - Silver
 - Sold individually
- SKU: TD-BPC



KEPROTEC® KEVLAR® SAND DISC W/ FOAM HANDLES

Our Sand Disc with Foam Handles provide extra grip on the edges for added exercises, control, and grip strength. This highly durable sand disc keeps its shape due to its heavy-duty construction. Filled with steel sand, the shape enhances workouts due to the shift in the sand during use. Soft weight prevents damage to the user and to the floor.

SKU	DESCRIPTION	DIAMETER	WEIGHT
TD-SD-KEV-5lb	KEVLAR SAND DISC	23 cm	5 lb
TD-SD-KEV-10lb	KEVLAR SAND DISC	29 cm	10 lb
TD-SD-KEV-15lb	KEVLAR SAND DISC	33.5 cm	15 lb
TD-SD-KEV-20lb	KEVLAR SAND DISC	38.5 cm	20 lb
TD-SD-KEV-25lb	KEVLAR SAND DISC	41.5 cm	25 lb
TD-SD-KEV-30lb	KEVLAR SAND DISC	44.5 cm	30 lb
TD-SD-KEV-35lb	KEVLAR SAND DISC	46 cm	35 lb
TD-SD-KEV-40lb	KEVLAR SAND DISC	48 cm	40 lb
TD-SD-KEV-45lb	KEVLAR SAND DISC	49.5 cm	45 lb
TD-SD-KEV-50lb	KEVLAR SAND DISC	50 cm	50 lb



KEPROTEC® KEVLAR® SANDBAG

This extremely durable sandbag will help you take your total body workouts to a new level. The Kevlar® fiber cover featuring 5 nylon handles with reinforced stitching allows for the most heavy of use. Special interior construction prevents weight from shifting around in bag and helps the bag maintain its shape. All bags come prefilled with weight so no filling required.

SKU	DESCRIPTION	WEIGHT	SKU	DESCRIPTION	WEIGHT
TD-SB-KEP-10lb	KEVLAR SAND BAG	10 lbS	TD-SB-KEP-5kg	KEVLAR SAND BAG	5 kg
TD-SB-KEP-20lb	KEVLAR SAND BAG	20 lbS	TD-SB-KEP-10kg	KEVLAR SAND BAG	10 kg
TD-SB-KEP-30lb	KEVLAR SAND BAG	30 lbS	TD-SB-KEP-15kg	KEVLAR SAND BAG	15 kg
TD-SB-KEP-40lb	KEVLAR SAND BAG	40 lbS	TD-SB-KEP-20kg	KEVLAR SAND BAG	20 kg
TD-SB-KEP-50lb	KEVLAR SAND BAG	50 lbS	TD-SB-KEP-25kg	KEVLAR SAND BAG	25 kg
			TD-SB-KEP-30kg	KEVLAR SAND BAG	30 kg

FIT ACCESSORIES

Kevlar

14" KEPROTEC® KEVLAR® MEDICINE BALL

The toughest and only reinforced medicine ball with DuPont™ Kevlar® fiber on the market. This extremely durable and low-bounce ball keeps its shape due to its patented construction. Perfect for the large variety of exercises performed by athletes of all types.

SKU	DESCRIPTION	WEIGHT
TD-MB-KEP-14in-4lb	KEVLAR MEDICINE BALL	4 lb
TD-MB-KEP-14in-6lb	KEVLAR MEDICINE BALL	6 lb
TD-MB-KEP-14in-8lb	KEVLAR MEDICINE BALL	8 lb
TD-MB-KEP-14in-10lb	KEVLAR MEDICINE BALL	10 lb
TD-MB-KEP-14in-12lb	KEVLAR MEDICINE BALL	12 lb
TD-MB-KEP-14in-14lb	KEVLAR MEDICINE BALL	14 lb
TD-MB-KEP-14in-16lb	KEVLAR MEDICINE BALL	16 lb
TD-MB-KEP-14in-18lb	KEVLAR MEDICINE BALL	18 lb
TD-MB-KEP-14in-20lb	KEVLAR MEDICINE BALL	20 lb
TD-MB-KEP-14in-25lb	KEVLAR MEDICINE BALL	25 lb
TD-MB-KEP-14in-30lb	KEVLAR MEDICINE BALL	30 lb
TD-MB-KEP-14in-35lb	KEVLAR MEDICINE BALL	35 lb
TD-MB-KEP-14in-40lb	KEVLAR MEDICINE BALL	40 lb
TD-MB-KEP-14in-45lb	KEVLAR MEDICINE BALL	45 lb
TD-MB-KEP-14in-50lb	KEVLAR MEDICINE BALL	50 lb

SKU	DESCRIPTION	WEIGHT
TD-MB-KEP-14in-2kg	KEVLAR MEDICINE BALL	2 kg
TD-MB-KEP-14in-4kg	KEVLAR MEDICINE BALL	4 kg
TD-MB-KEP-14in-6kg	KEVLAR MEDICINE BALL	6 kg
TD-MB-KEP-14in-8kg	KEVLAR MEDICINE BALL	8 kg
TD-MB-KEP-14in-10kg	KEVLAR MEDICINE BALL	10 kg
TD-MB-KEP-14in-12kg	KEVLAR MEDICINE BALL	12 kg
TD-MB-KEP-14in-14kg	KEVLAR MEDICINE BALL	14 kg
TD-MB-KEP-14in-16kg	KEVLAR MEDICINE BALL	16 kg
TD-MB-KEP-14in-18kg	KEVLAR MEDICINE BALL	18 kg
TD-MB-KEP-14in-20kg	KEVLAR MEDICINE BALL	20 kg



KEVLAR® RUBBER MEDICINE BALL

This uniquely designed medicine ball is one of a kind. We used tire technology to combine the best natural rubber with DuPont™ Kevlar® fiber making this the most durable medicine ball on the market. This is truly an evolution in a product that hasn't seen progress in decades. Unique custom pattern provides grippy texture to aid in catching, throwing, slamming, or moving with the ball in general. This ball has a medium bounce to it and is not a dead bounce slam ball.

SKU	DESCRIPTION	WEIGHT
TD-RMB-KEV-4lb	XD RUBBER MED BALL WITH KEVLAR	4 lb
TD-RMB-KEV-6lb	XD RUBBER MED BALL WITH KEVLAR	6 lb
TD-RMB-KEV-8lb	XD RUBBER MED BALL WITH KEVLAR	8 lb
TD-RMB-KEV-10lb	XD RUBBER MED BALL WITH KEVLAR	10 lb
TD-RMB-KEV-12lb	XD RUBBER MED BALL WITH KEVLAR	12 lb
TD-RMB-KEV-15lb	XD RUBBER MED BALL WITH KEVLAR	15 lb
TD-RMB-KEV-20lb	XD RUBBER MED BALL WITH KEVLAR	20 lb
TD-RMB-KEV-25lb	XD RUBBER MED BALL WITH KEVLAR	25 lb
TD-RMB-KEV-30lb	XD RUBBER MED BALL WITH KEVLAR	30 lb

SKU	DESCRIPTION	WEIGHT
TD-RMB-KEV-2kg	XD RUBBER MED BALL WITH KEVLAR	2 kg
TD-RMB-KEV-3kg	XD RUBBER MED BALL WITH KEVLAR	3 kg
TD-RMB-KEV-4kg	XD RUBBER MED BALL WITH KEVLAR	4 kg
TD-RMB-KEV-5kg	XD RUBBER MED BALL WITH KEVLAR	5 kg
TD-RMB-KEV-6kg	XD RUBBER MED BALL WITH KEVLAR	6 kg
TD-RMB-KEV-8kg	XD RUBBER MED BALL WITH KEVLAR	8 kg
TD-RMB-KEV-10kg	XD RUBBER MED BALL WITH KEVLAR	10 kg
TD-RMB-KEV-12kg	XD RUBBER MED BALL WITH KEVLAR	12 kg
TD-RMB-KEV-14kg	XD RUBBER MED BALL WITH KEVLAR	14 kg



14" TACTEC KEVLAR® MEDICINE BALL

Our medicine ball features a new cover constructed of high tensile TacTec™ Kevlar®, delivering increased durability and grip when compared to traditional medicine balls.

SKU	DESCRIPTION	WEIGHT
TD-MB-TAC-14in-4lb	XD MEDICInE BALL KEVLAR	4 lb
TD-MB-TAC-14in-6lb	XD MEDICInE BALL KEVLAR	6 lb
TD-MB-TAC-14in-8lb	XD MEDICInE BALL KEVLAR	8 lb
TD-MB-TAC-14in-10lb	XD MEDICInE BALL KEVLAR	10 lb
TD-MB-TAC-14in-12lb	XD MEDICInE BALL KEVLAR	12 lb
TD-MB-TAC-14in-14lb	XD MEDICInE BALL KEVLAR	14 lb
TD-MB-TAC-14in-16lb	XD MEDICInE BALL KEVLAR	16 lb
TD-MB-TAC-14in-18lb	XD MEDICInE BALL KEVLAR	18 lb
TD-MB-TAC-14in-20lb	XD MEDICInE BALL KEVLAR	20 lb
TD-MB-TAC-14in-25lb	XD MEDICInE BALL KEVLAR	25 lb
TD-MB-TAC-14in-30lb	XD MEDICInE BALL KEVLAR	30 lb

SKU	DESCRIPTION	WEIGHT
TD-MB-TAC-14in-2kg	XD MEDICInE BALL KEVLAR	2 kg
TD-MB-TAC-14in-3kg	XD MEDICInE BALL KEVLAR	3 kg
TD-MB-TAC-14in-4kg	XD MEDICInE BALL KEVLAR	4 kg
TD-MB-TAC-14in-5kg	XD MEDICInE BALL KEVLAR	5 kg
TD-MB-TAC-14in-6kg	XD MEDICInE BALL KEVLAR	6 kg
TD-MB-TAC-14in-7kg	XD MEDICInE BALL KEVLAR	7 kg
TD-MB-TAC-14in-8kg	XD MEDICInE BALL KEVLAR	8 kg
TD-MB-TAC-14in-9kg	XD MEDICInE BALL KEVLAR	9 kg
TD-MB-TAC-14in-10kg	XD MEDICInE BALL KEVLAR	10 kg
TD-MB-TAC-14in-12kg	XD MEDICInE BALL KEVLAR	12 kg
TD-MB-TAC-14in-14kg	XD MEDICInE BALL KEVLAR	14 kg

XD SLAM BALL

Our best Slam Ball is designed to elevate your workouts with its grooved tire tread texture, no-slip grip, and bounce-resistant construction. Perfect for cardio, agility, and strength training, this versatile tool helps you build muscle, ignite your core, enhance rotational power, and unleash your full potential through high-energy slams.

SKU	DESCRIPTION	WEIGHT
TD-Slb-XD-6lb	XD SLAM BALL	6 lb
TD-Slb-XD-8lb	XD SLAM BALL	8 lb
TD-Slb-XD-10lb	XD SLAM BALL	10 lb
TD-Slb-XD-15lb	XD SLAM BALL	15 lb
TD-Slb-XD-20lb	XD SLAM BALL	20 lb
TD-Slb-XD-25lb	XD SLAM BALL	25 lb
TD-Slb-XD-30lb	XD SLAM BALL	30 lb
TD-Slb-XD-40lb	XD SLAM BALL	40 lb
TD-Slb-XD-50lb	XD SLAM BALL	50 lb
TD-MB-TAC-14in-25lb	XD SLAM BALL	25 lb
TD-MB-TAC-14in-30lb	XD SLAM BALL	30 lb

SKU	DESCRIPTION	WEIGHT
TD-Slb-XD-3kg	XD SLAM BALL	3 kg
TD-Slb-XD-4kg	XD SLAM BALL	4 kg
TD-Slb-XD-5kg	XD SLAM BALL	5 kg
TD-Slb-XD-7kg	XD SLAM BALL	7 kg
TD-Slb-XD-9kg	XD SLAM BALL	9 kg
TD-Slb-XD-12kg	XD SLAM BALL	12 kg
TD-Slb-XD-14kg	XD SLAM BALL	14 kg
TD-Slb-XD-18kg	XD SLAM BALL	18 kg
TD-Slb-XD-22kg	XD SLAM BALL	22 kg

FITNESS ANYWHERE

As the digital fitness market leader, Wexer provides access to world class content to thousands of organisations around the world. We work with leading content providers to create the world's largest wellness library, all licensed for global use.

Our secure, ever-evolving digital ecosystem, including virtual, mobile, app, and web player, ensures seamless content delivery. These platforms provide data-driven solutions that align with our mission: to equip and empower people to be fit, healthy, and happy.



WEXER VIRTUAL

The world's leading fitness instructors. in your studio. On demand. Round the clock.



WEB PLAYER AND APP

The Wexer Web Player is a white-labeled, web-based product that allows your members to stream exercise classes and content to any internet-enabled device, 24/7.

WEXER API

The Wexer API unlock the content that resides in the Wexer ecosystem – the world-class content that we curate from our global content partners – so it can be extracted and dropped into your own digital ecosystems.

EDUCATION

COREFIT COLLECTIVE

TRAIN WITH PROVEN IMPACT

Where Instructors Evolve. Communities Grow. Education Becomes Culture.

CoreFit Collective is the educational backbone of the Core ecosystem, designed to elevate instructors, strengthen facilities, and create meaningful training experiences rooted in evidence-based practice.

Whether you're coaching, leading a team, or building a facility culture, CoreFit meets you where you are and helps you grow with intention.

- Become a Better Coach** -> Instructor Training (Live & Online)
- Experience the Energy** -> CoreFit Summit
- Keep Learning Anytime** -> CoreFit App
- Bring Education to Your Facility** -> Host a Training

EDUCATION WITH PURPOSE. COMMUNITY WITH IMPACT.

CoreFit Collective connects instructors, trainers, managers, and operators through education that translates into confidence, consistency, and better member experiences.

BUILT ON EVIDENCE-BASED PRACTICE, COREFIT BALANCES:

- Peer-reviewed science
- Real-world coaching application
- Individual needs and response

THE RESULT

Education that works on the floor, not just on paper.

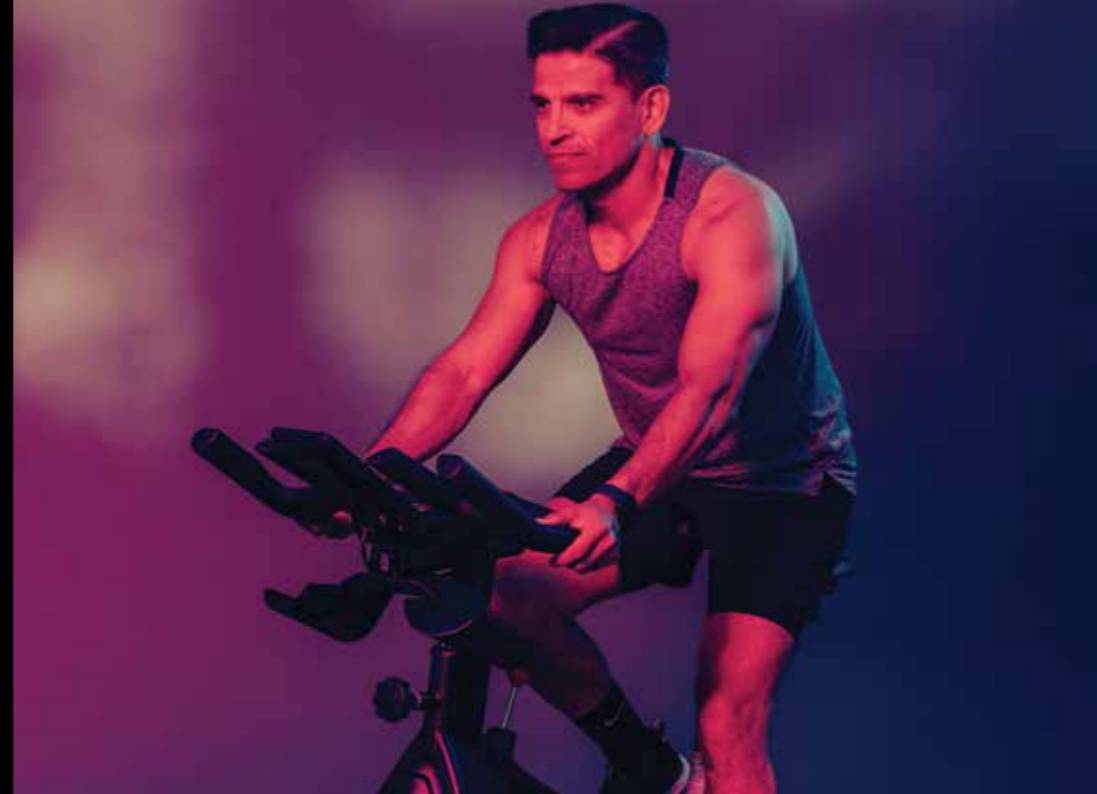

EXPLORE YOUR OPTIONS
BY SCANNING THE QR
CODE OR VISIT
<https://corehandf.com/corefit-collective>

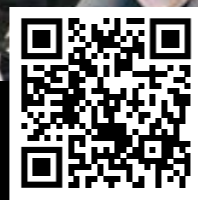

INSTRUCTOR TRAINING

Build confidence. Master coaching. Deliver better results.

Hands-on live trainings and flexible online courses across six CoreFit modalities, designed to help you coach with clarity, purpose, and impact.

- Available Live and Online
- Learn from Master Instructors
- Develop scalable, real-world programming skills
- Build credibility with members and facilities

COREFIT APP

Your on-the-go learning companion.

The CoreFit App extends education beyond the classroom with short-format learning, coaching tips, workouts, and playlists, designed to support instructors anytime, anywhere.

- Monthly content refreshes
- Optional specialty bundles in cycle, strength, and HIIT
- Community connection and creative inspiration

Note: App content does not include CEUs.

COREFIT SUMMIT

A high-energy weekend where education becomes culture.

The CoreFit Summit brings instructors, operators, and industry leaders together for live workouts, education, and community—powered by Core's iconic brands.

- Experience Schwinn, StairMaster, Nautilus, Star Trac, and Throwdown in action
- Learn from top educators and thought leaders
- Leave with ideas you can apply immediately

HOST A TRAINING

Turn your facility into a hub of education and energy.

Bring CoreFit Instructor Training directly to your facility to develop your team, inspire your members, and strengthen your brand as a destination for professional growth.

- Upskill instructors through hands-on education
- Build loyalty and engagement
- Attract new professionals and potential members.

CUSTOMER SERVICE

Support isn't just something we offer—it's at the heart of what we do best. Our world-class services reach customers in over 90 countries, backed by a dedicated team that partners with you every step of the way, from pre-sale guidance to post-sale support. Our ultimate goal? To keep your facility running at peak performance with minimal equipment downtime.

CORE CONNECT

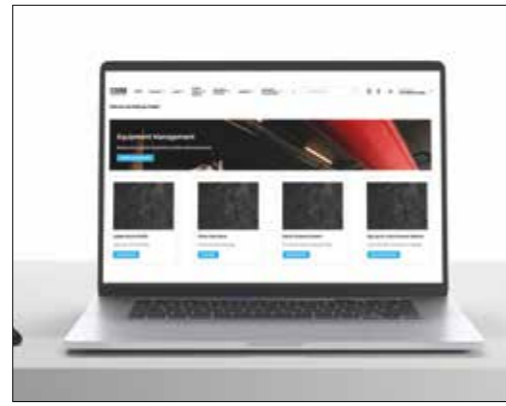

Get world class support for all of our brands with our Core Connect portal, a platform that simplifies the process for warranty registration, preventive maintenance, service requests, parts orders and allows you to get help with your general inquiries.

[CONNECT.COREHANDF.COM/](https://connect.corehandf.com/)

CORE ADVANTAGE



Our preventative maintenance program, Core Advantage, will help preserve your equipment as excessive use takes its toll and ensures the longest possible life of your products while reducing downtime. We offer programs for all aspects of gym equipment, in every category and for every Core Health & Fitness brand. Core Advantage provides the industry's most complete programs; including one-time, monthly, once every other month, semi-annual and quarterly options available.



BENEFITS OF CORE HEALTH & FITNESS CUSTOMER SERVICE

connect.corehandf.com for preventative maintenance schedules, owner's manuals, and other online support

Customer Support Center

24/7 Chat Support
hosted by AI agents

Live Agent Support
available from
6am to 4pm PST

Network of 600+ factory-trained, annually-certified service providers

in-service seminars for staff



SCAN THE QR CODE ABOVE TO LEARN MORE ABOUT OUR WORLD-CLASS CUSTOMER SERVICE



CORE

HEALTH & FITNESS

GLOBAL SUPPORT CENTER

17800 SE Mill Plain Blvd. Suite 190
Vancouver, WA 98683
Tel: +1 (888) 678-2476
sales@corehandf.com

OUR OTHER LOCATIONS:

GLOBAL INNOVATION CENTER

Lake Forest, CA
Tel: +1 (800) 228-6635
sales@corehandf.com

EMEA SUPPORT CENTER

High Wycombe, Buckinghamshire
Tel: +44 (0) 1494 688260
uksales@corehandf.com

GERMANY

Munich, Germany
Tel: +49 89 2189800
sales-de@corehandf.com

BRAZIL

Rio de Janeiro, Brazil
Tel: +55 (19) 3837 3047
sales@corehandf.com

ASIA PACIFIC

Xiamen, China
Tel: +86 (0) 592 624 8296
salesAPLA@corehandf.com